

## Schottky Diodes

### 1KK2202D ~ 1KK2220D

#### ■ Features

- Metal silicon junction, majority carrier conduction
- For surface mounted applications
- Low power loss, high efficiency
- High forward surge current capability
- For use in low voltage, high frequency inverters, free wheeling, and polarity protection applications

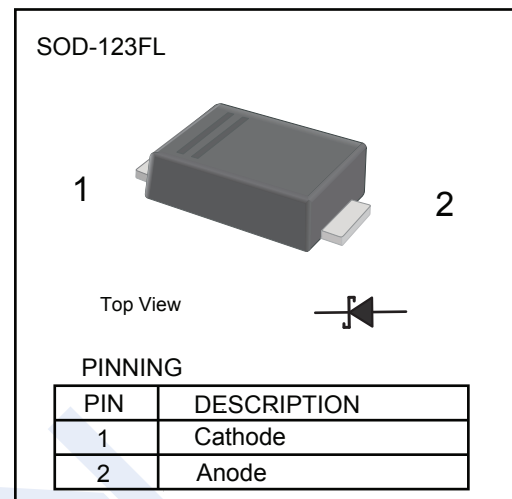

#### ■ Absolute Maximum Ratings and Electrical characteristics

Ratings at 25°C ambient temperature unless otherwise specified.

Single phase half-wave 60 Hz, resistive or inductive load, for capacitive load current derate by 20 %.

Parameter	Symbols	1KK 2202D	1KK 2204D	1KK 2206D	1KK 2210D	1KK 2215D	1KK 2220D	Unit	
Maximum Repetitive Peak Reverse Voltage	$V_{RRM}$	20	40	60	100	150	200	V	
Maximum RMS voltage	$V_{RMS}$	14	28	42	70	105	140		
Maximum DC Blocking Voltage	$V_{DC}$	20	40	60	100	150	200		
Maximum Instantaneous Forward Voltage at 2A	$V_F$	0.55		0.70	0.85	0.95		A	
Maximum Averaged Forward Rectified Current	$I_{F(AV)}$	2.0							
Peak Forward Surge Current, 8.3 ms Single Half Sine Wave Superimposed on Rated Load	$I_{FSM}$	50							
Maximum DC Reverse Current $T_a=25^\circ\text{C}$ at rated DC blocking voltage $T_a=100^\circ\text{C}$	$I_R$	0.5 5			0.3 3			mA	
Typical Junction Capacitance *1	$C_j$	220			80			pF	
Typical Thermal Resistance *2	$R_{\theta JA}$	85							°C/W
Operating Junction Temperature Range	$T_j$	-55 ~ +125							°C
Storage Temperature Range	$T_{stg}$	-55 ~ +150							

\* 1 Measured at 1MHz and applied reverse voltage of 4V D.C.

\* 2 P.C.B. mounted with 2.0" × 2.0" (5×5 cm) copper pad areas.

#### ■ Marking

NO.	1KK 2202D	1KK 2204D	1KK 2206D	1KK 2210D	1KK 2215D	1KK 2220D
Marking	DC	DD	DE	DF	DG	DH

# Schottky Diodes

## 1KK2202D ~ 1KK2220D

■ Typical Characteristics

Fig.1 Forward Current Derating Curve

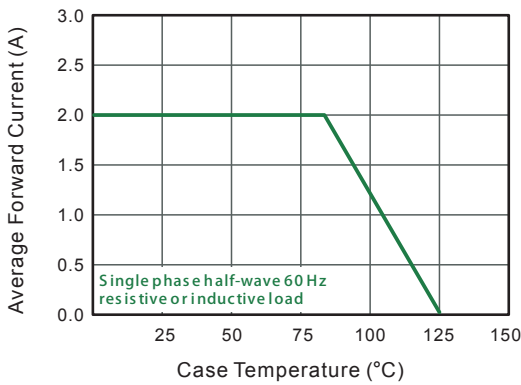

Fig.2 Typical Reverse Characteristics

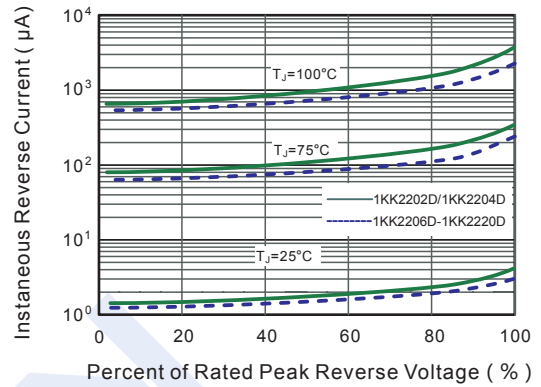

Fig.3 Typical Forward Characteristic

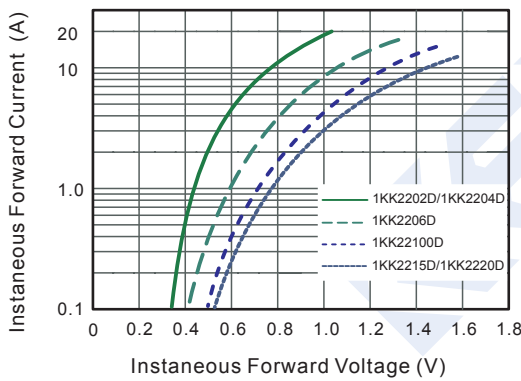

Fig.4 Typical Junction Capacitance

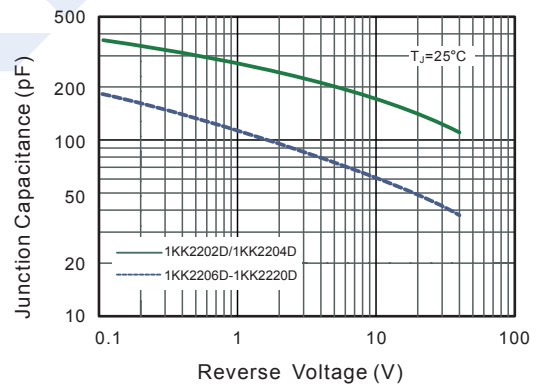

Fig.5 Maximum Non-Repetitive Peak Forward Surge Current

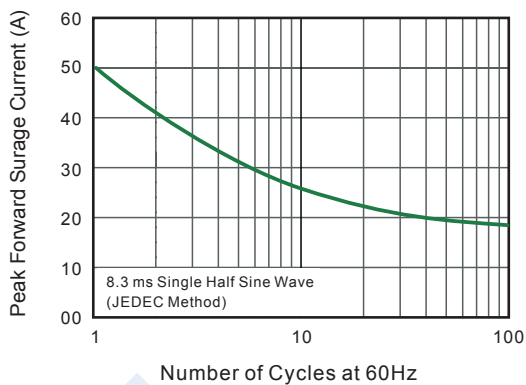
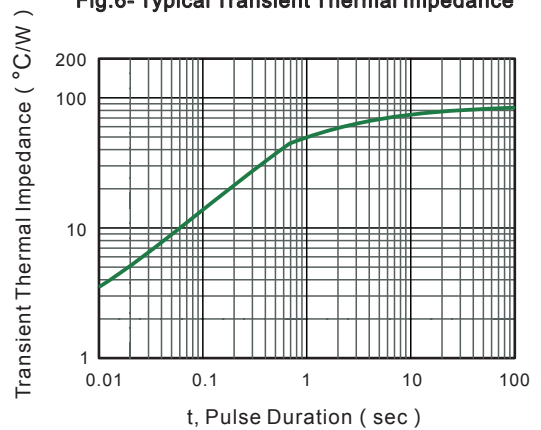

Fig.6- Typical Transient Thermal Impedance



## Schottky Diodes

### 1KK2202D ~ 1KK2220D

■ Package Outline Dimensions

Plastic surface mounted package; 2 leads

SOD-123FL

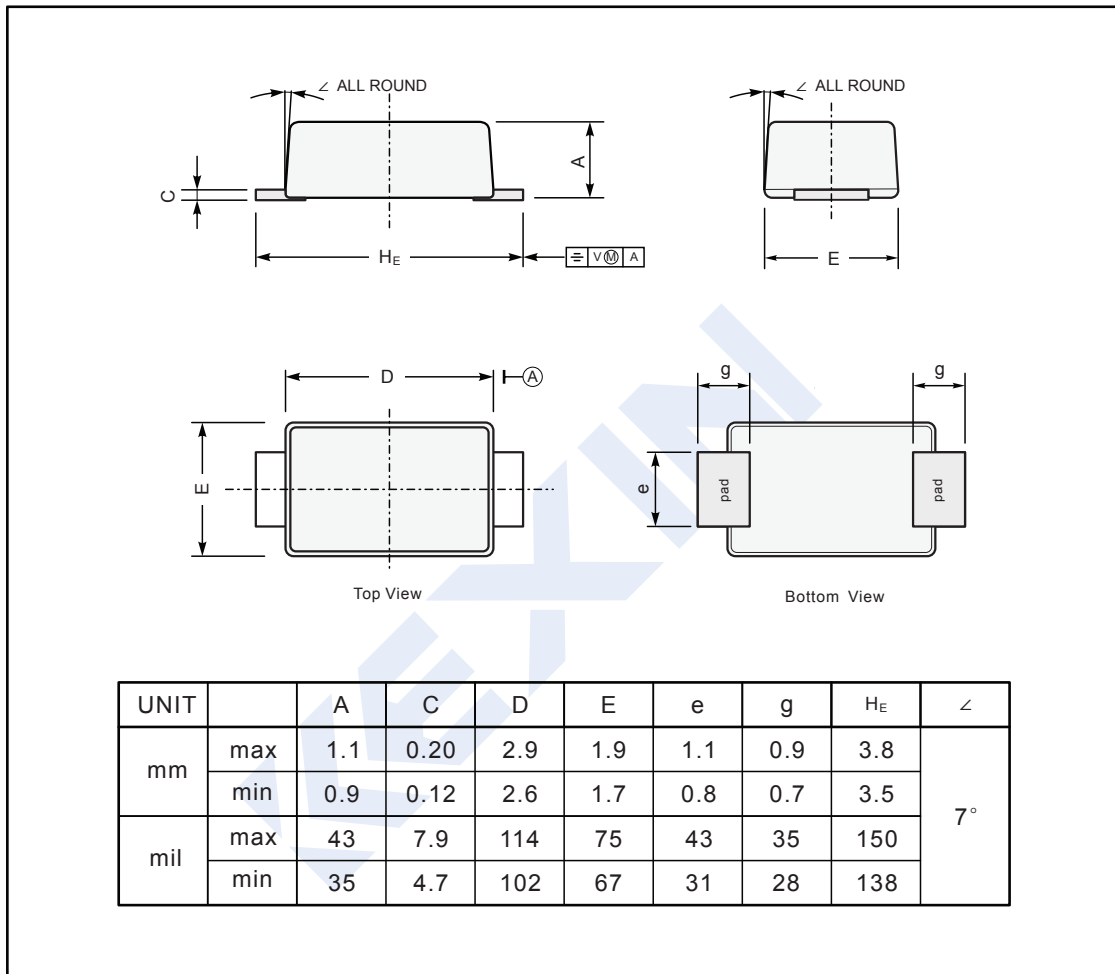

■ The Recommended Mounting Pad Size

