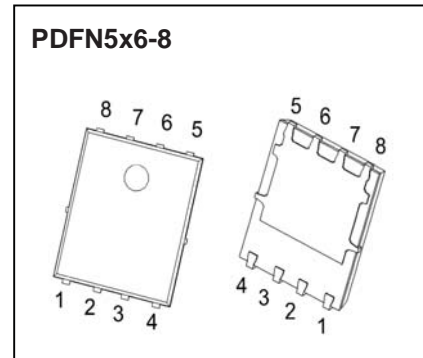
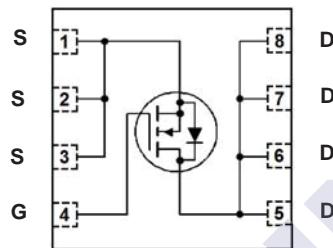

N-Channel MOSFET

2KK5042DFN

■ Features

- $V_{DS} (V) = 100 V$
- $I_D = 50 A$
- $R_{DS(ON)} (at V_{GS} = 10 V) < 14 m\Omega$
- $R_{DS(ON)} (at V_{GS} = 4.5 V) < 16 m\Omega$

■ Absolute Maximum Ratings ($T_C = 25^\circ C$ unless otherwise noted)

Parameter	Symbol	Rating	Unit
Drain-Source Voltage	V_{DS}	100	V
Gate-Source Voltage	V_{GS}	± 20	
Continuous Drain Current	Package Limited	50	A
		$T_C = 100^\circ C$	
Pulsed Drain Current (Note 1)	I_{DM}	150	
Power Dissipation	P_D	105	W
Derating factor		0.84	$W/^\circ C$
Single Pulse Avalanche Energy (Note 2)	E_{AS}	250	mJ
Thermal Resistance Junction- to-Case (Note 3)	$R_{\theta JC}$	1.2	$^\circ C/W$
Junction Temperature	T_J	150	$^\circ C$
Storage Temperature Range	T_{stg}	-55 to 150	

Notes:

1. Repetitive Rating: Pulse width limited by maximum junction temperature.
2. EAS condition : $T_J = 25^\circ C, V_{DD} = 50V, V_{GS} = 10V, L = 0.5mH, R_g = 25\Omega$
3. Surface Mounted on FR4 Board, $t \leq 10$ sec.

N-Channel MOSFET

2KK5042DFN

■ Electrical Characteristics (T_c = 25°C unless otherwise specified)

Parameter	Symbol	Test Conditions	Min	Typ	Max	Unit
Off Characteristics						
Drain-Source Breakdown Voltage	BV _{DSS}	I _D = 250 μA, V _{GS} = 0V	100			V
Zero Gate Voltage Drain Current	I _{DSS}	V _{DS} = 100 V, V _{GS} = 0 V			1	μA
Gate to Source Leakage Current	I _{GSS}	V _{DS} = 0 V, V _{GS} = ±20 V			±100	nA
On Characteristics (Note 1)						
Gate to Source Threshold Voltage	V _{GS(th)}	V _{DS} = V _{GS} , I _D = 250μA	1.0	1.7	2.2	V
Static Drain-Source On-Resistance	R _{DS(on)}	V _{GS} = 10 V, I _D = 12 A		11.5	14	mΩ
		V _{GS} = 4.5 V, I _D = 12 A		12.6	16	
Forward Transconductance	g _{FS}	V _{DS} = 10 V, I _D = 30 A	40			S
Dynamic Characteristics (Note 1)						
Input Capacitance	C _{iss}	V _{GS} = 0 V, V _{DS} = 50 V, f = 1 MHz		4200		pF
Output Capacitance	C _{oss}			354		
Reverse Transfer Capacitance	C _{rss}			23		
Switching Characteristics (Note 1)						
Total Gate Charge	Q _g	V _{GS} = 10V, V _{DS} = 50 V, I _D = 30 A		58		nC
Gate Source Charge	Q _{gs}			12		
Gate Drain Charge	Q _{gd}			7.8		
Turn-On Delay Time	t _{d(on)}	V _{GS} = 10V, V _{DD} = 50 V, I _D = 30A, R _G = 4.7 Ω		14		ns
Turn-On Rise Time	t _r			9		
Turn-Off Delay Time	t _{d(off)}			39		
Turn-Off Fall Time	t _f			5		
Drain-Source Diode Characteristics						
Body Diode Reverse Recovery Time	t _{rr}	I _F = I _S , di/dt = 100 A/μs, T _J = 25°C		58		ns
Body Diode Reverse Recovery Charge	Q _{rr}			110		nC
Maximum Body-Diode Continuous Current	I _S				50	A
Diode Forward Voltage	V _{SD}	V _{GS} = 0 V, I _S = 50 A			1.2	V

Notes:

1. Pulse Test: Pulse Width ≤ 300μs, Duty Cycle ≤ 2%.

■ Marking

Marking	K5042 KC****
---------	-----------------

N-Channel MOSFET

2KK5042DFN

Typical Electrical and Thermal Characteristics

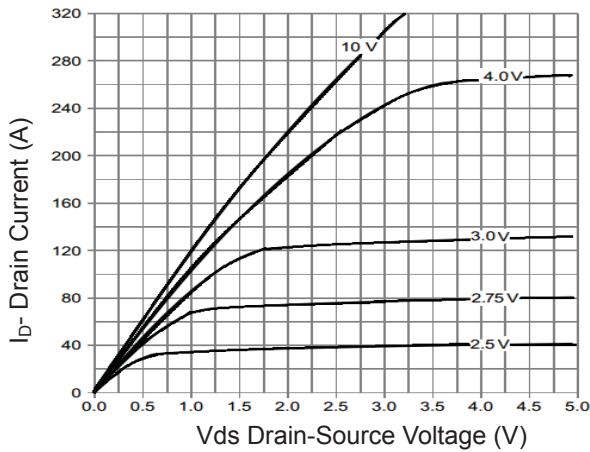

Figure 1 Output Characteristics

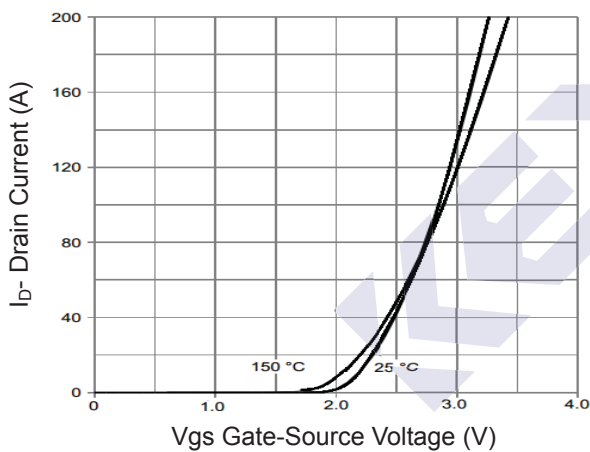

Figure 2 Transfer Characteristics

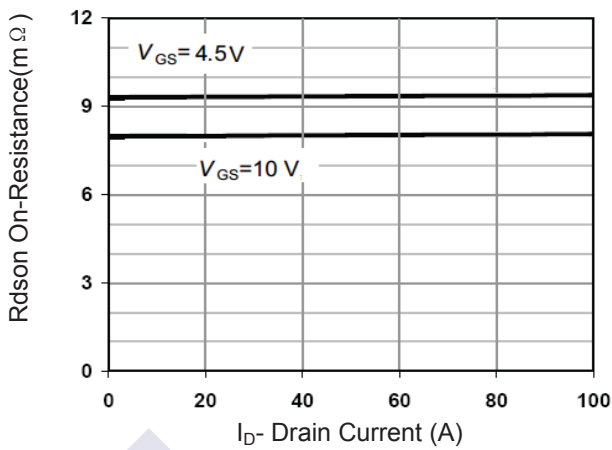

Figure 3 $R_{DS(on)}$ - Drain Current

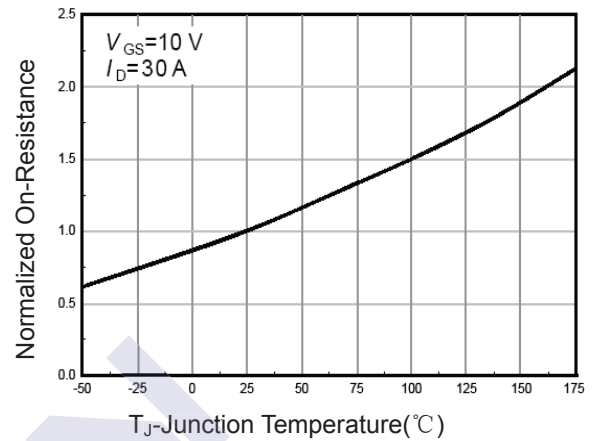

Figure 4 $R_{DS(on)}$ -Junction Temperature

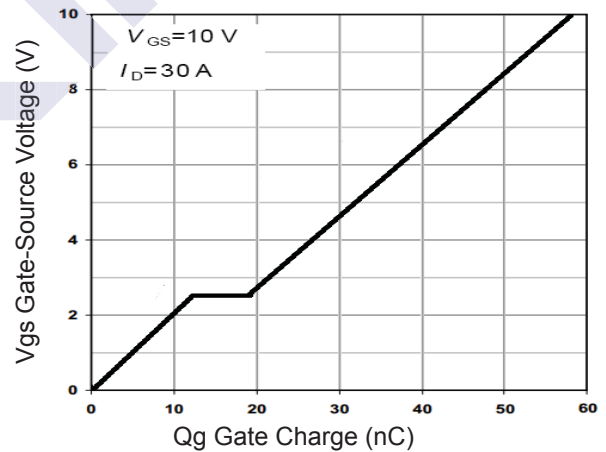

Figure 5 Gate Charge

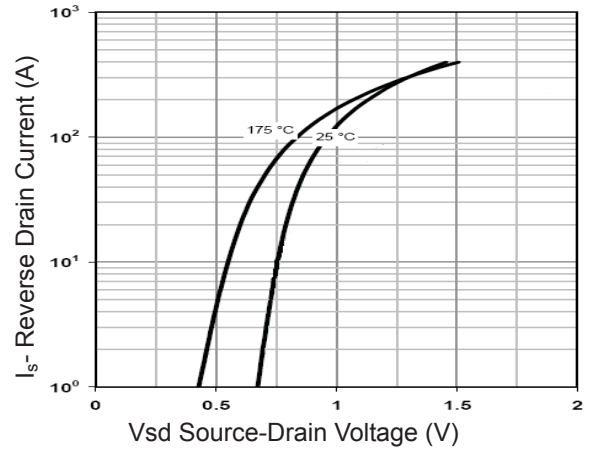

Figure 6 Source- Drain Diode Forward

N-Channel MOSFET

2KK5042DFN

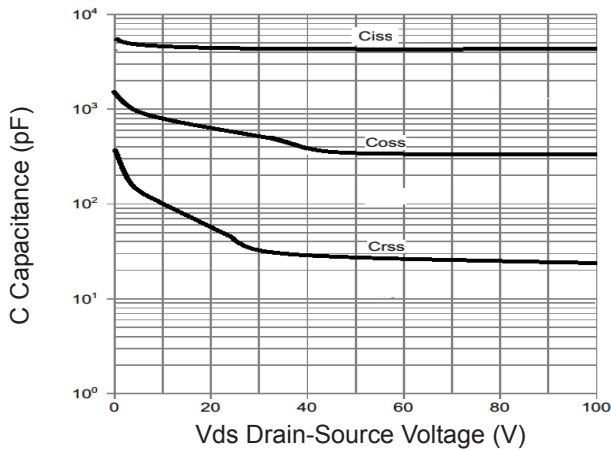

Figure 7 Capacitance vs Vds

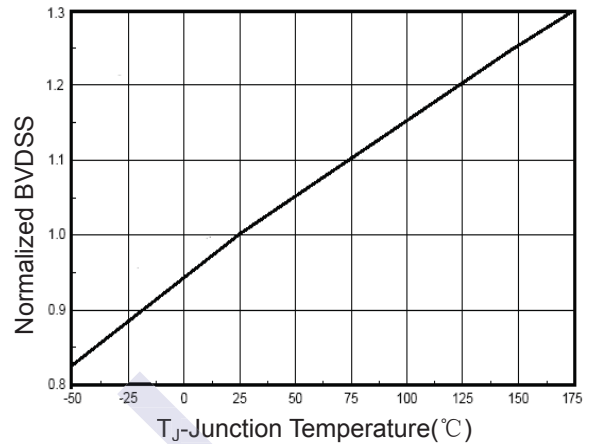

Figure 9 BV_{DSS} vs Junction Temperature

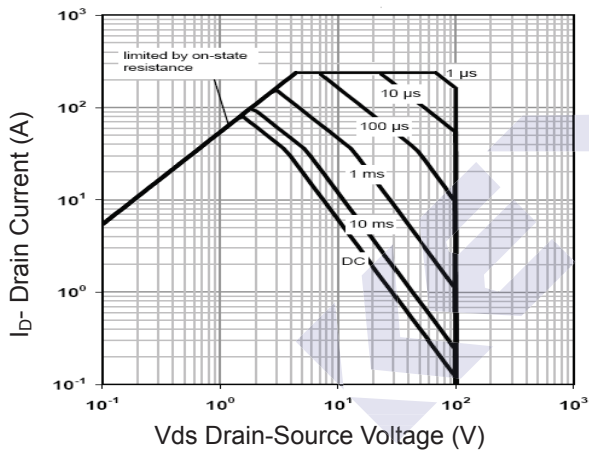

Figure 8 Safe Operation Area

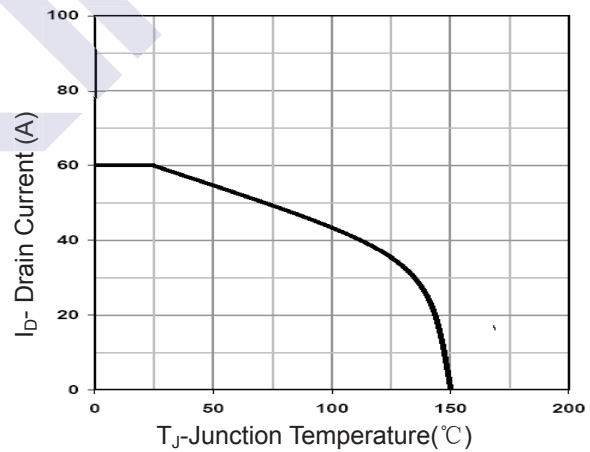

Figure 10 Current De-rating

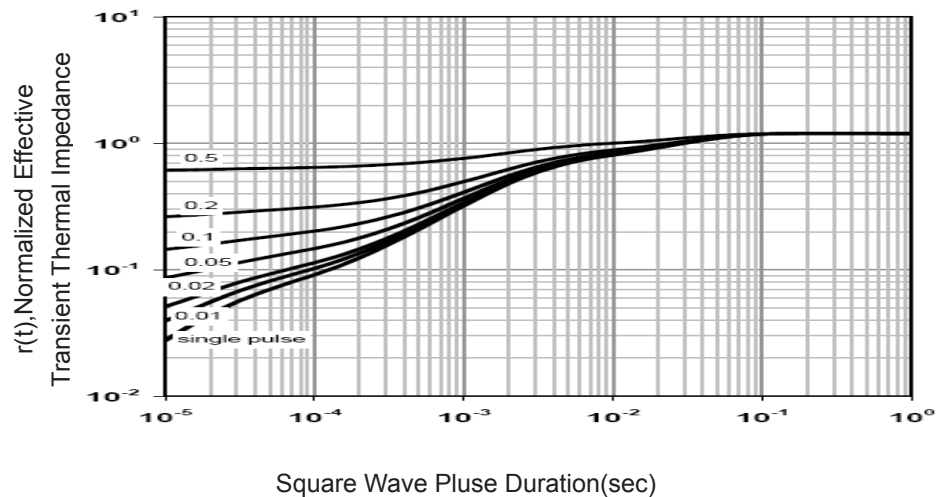
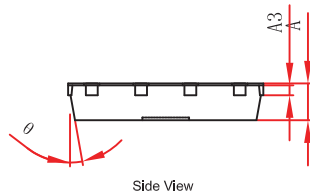
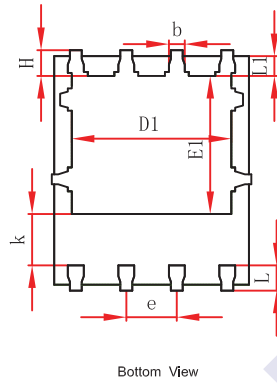
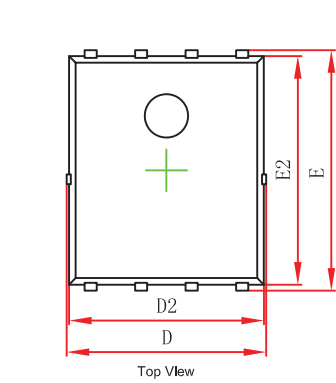

Figure 11 Normalized Maximum Transient Thermal Impedance

N-Channel MOSFET

2KK5042DFN

PDFN5x6-8 Package Outline Dimensions



Symbol	Dimensions In Millimeters		Dimensions In Inches	
	Min.	Max.	Min.	Max.
A	0.900	1.000	0.035	0.039
A3	0.254REF.		0.010REF.	
D	4.944	5.096	0.195	0.201
E	5.974	6.126	0.235	0.241
D1	3.910	4.110	0.154	0.162
E1	3.375	3.575	0.133	0.141
D2	4.824	4.976	0.190	0.196
E2	5.674	5.826	0.223	0.229
k	1.190	1.390	0.047	0.055
b	0.350	0.450	0.014	0.018
e	1.270TYP.		0.050TYP.	
L	0.559	0.711	0.022	0.028
L1	0.424	0.576	0.017	0.023
H	0.574	0.726	0.023	0.029
θ	10°	12°	10°	12°

PDFN5x6-8 Suggested Pad Layout

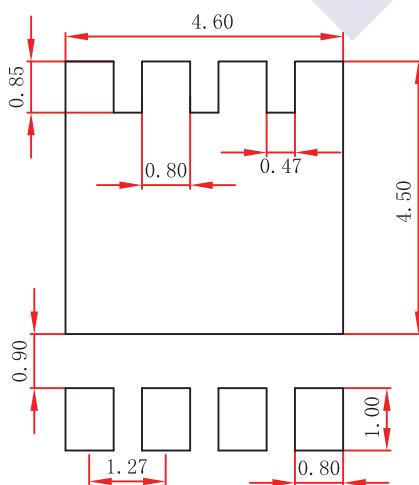

- Note:
1. Controlling dimension: in millimeters.
 2. General tolerance: $\pm 0.05\text{mm}$.
 3. The pad layout is for reference purposes only.