

Complementary Trench MOSFET

2NP03

■ Features

N-Channel

- $V_{DS} (V) = 12V$
- $I_D = 4.5 A (V_{GS} = 4.5V)$
- $R_{DS(ON)} < 29m\Omega (V_{GS} = 4.5V)$
- $R_{DS(ON)} < 34m\Omega (V_{GS} = 2.5V)$
- $R_{DS(ON)} < 44m\Omega (V_{GS} = 1.8V)$
- $R_{DS(ON)} < 65m\Omega (V_{GS} = 1.5V)$

P-Channel

- $V_{DS} (V) = -12V$
- $I_D = -4.5 A (V_{GS} = -4.5V)$
- $R_{DS(ON)} < 61m\Omega (V_{GS} = -4.5V)$
- $R_{DS(ON)} < 81m\Omega (V_{GS} = -2.5V)$
- $R_{DS(ON)} < 115m\Omega (V_{GS} = -1.8V)$
- $R_{DS(ON)} < 170m\Omega (V_{GS} = -1.5V)$

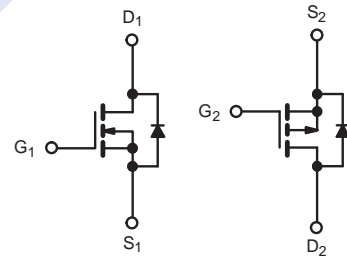
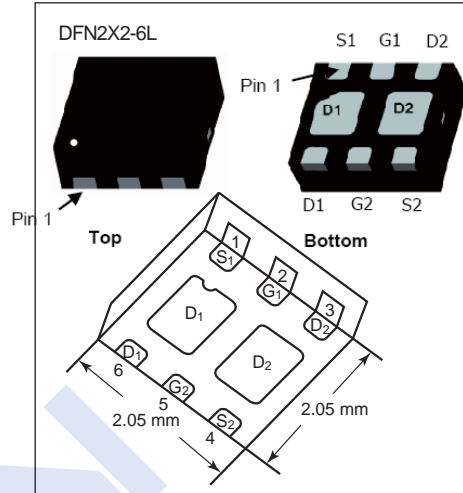

N-Channel MOSFET P-Channel MOSFET

■ Absolute Maximum Ratings $T_a = 25^\circ C$

Parameter		Symbol	N-Channel	P-Channel	Unit
Drain-Source Voltage		V_{DS}	12	-12	V
Gate-Source Voltage		V_{GS}	± 8		
Continuous Drain Current	$T_C=25^\circ C$	I_D	4.5	-4.5	A
	$T_C=70^\circ C$		4.5	-4.5	
	$T_A=25^\circ C$		4.5	-4.3	
	$T_A=70^\circ C$		4.5	-3.8	
Pulsed Drain Current		I_{DM}	20	-15	
Power Dissipation	$T_C=25^\circ C$	P_D	6.5		W
	$T_C=70^\circ C$		5		
	$T_A=25^\circ C$		1.9		
	$T_A=70^\circ C$		1.2		
Thermal Resistance.Junction- to-Ambient	$t \leq 5s$	R_{thJA}	65		$^\circ C/W$
Thermal Resistance.Junction- to-Case		R_{thJC}	16		
Junction Temperature		T_J	150		$^\circ C$
Storage Temperature Range		T_{stg}	-55 to 150		

Complementary Trench MOSFET

2NP03

■ Electrical Characteristics Ta = 25°C

Parameter	Symbol	Test Conditions	Type	Min	Typ	Max	Unit
Drain-Source Breakdown Voltage	V _{DSS}	I _D =250 μA, V _{GS} =0V	N-CH	12			V
		I _D =-250 μA, V _{GS} =0V	P-CH	-12			
Zero Gate Voltage Drain Current	I _{DSS}	V _{DS} =12V, V _{GS} =0V	N-CH			1	μA
		V _{DS} =-12V, V _{GS} =0V	P-CH			-1	
		V _{DS} =12V, V _{GS} =0V, T _J =55°C	N-CH			10	
		V _{DS} =-12V, V _{GS} =0V, T _J =55°C	P-CH			-10	
Gate-Body Leakage Current	I _{GSS}	V _{DS} =0V, V _{GS} =±8V	N-CH			±100	nA
		V _{DS} =0V, V _{GS} =±8V	P-CH			±100	
Gate Threshold Voltage	V _{GS(th)}	V _{DS} =V _{GS} , I _D =250 μA	N-CH	0.4		1	V
		V _{DS} =V _{GS} , I _D =-250 μA	P-CH	-0.4		-1	
Static Drain-Source On-Resistance	R _{DS(on)}	V _{GS} =4.5V, I _D =5A	N-CH			29	mΩ
		V _{GS} =2.5V, I _D =4.6A				34	
		V _{GS} =1.8V, I _D =4.1A				44	
		V _{GS} =1.5V, I _D =2A				65	
		V _{GS} =-4.5V, I _D =-3.6A	P-CH			61	
		V _{GS} =-2.5V, I _D =-3.2A				81	
		V _{GS} =-1.8V, I _D =-1A				115	
		V _{GS} =-1.5V, I _D =-1A				170	
On-State Drain Current	I _{D(on)}	V _{DS} ≥5 V, V _{GS} = 4.5 V	N-CH	15			A
		V _{DS} ≥-5 V, V _{GS} = -4.5 V	P-CH	-10			
Forward Transconductance	g _{FS}	V _{DS} =10V, I _D =5A	N-CH		21		S
		V _{DS} =-10V, I _D =-3.6A	P-CH		11		
Input Capacitance	C _{iss}	N-Channel: V _{GS} =0V, V _{DS} =6V, f=1MHz	N-CH		500		pF
Output Capacitance	C _{oss}		P-Channel: V _{GS} =0V, V _{DS} =6V, f=1MHz	N-CH		160	
		Reverse Transfer Capacitance	C _{rss}	N-Channel: V _{GS} =0V, V _{DS} =6V, f=1MHz	P-CH		
P-Channel: V _{GS} =0V, V _{DS} =6V, f=1MHz	N-CH				100		
Gate Resistance	R _g	V _{GS} =0V, f=1MHz	N-CH	0.7		7	Ω
			P-CH	2		20	
Total Gate Charge	Q _g	V _{GS} =8V, V _{DS} =6V, I _D =6.5A	N-CH		9.7	15	nC
		V _{GS} =-8V, V _{DS} =-6V, I _D =-4.5A	P-CH		13.1	20	
		N-Channel: V _{GS} =4.5V, V _{DS} =6V, I _D =6.5A	N-CH		5.6	8.5	
			P-CH		8.2	12.5	
Gate Source Charge	Q _{gs}	P-Channel: V _{GS} =-4.5V, V _{DS} =-6V, I _D =-4.3A	N-CH		0.72		
			P-CH		1.2		
Gate Drain Charge	Q _{gd}	N-Channel: V _{GS} =4.5V, V _{DS} =6V, I _D =6.5A	N-CH		0.74		
			P-CH		2.8		

Complementary Trench MOSFET

2NP03

■ Electrical Characteristics Ta = 25°C

Turn-On DelayTime	td(on)	N-Channel: VGS=4.5V, VDS=6V, ID=5.2A, RL=1.2Ω, RGEN=1Ω P-Channel: VGS=-4.5V, VDS=-6V, ID=-3.8A, RL=1.6Ω, RGEN=1Ω	N-CH	10	15	ns		
			P-CH	30	40			
Turn-On Rise Time	tr		N-CH	10	15			
			P-CH	25	40			
Turn-Off DelayTime	td(off)		N-CH	22	30			
			P-CH	30	45			
Turn-Off Fall Time	tf		N-CH	10	15			
			P-CH	20	30			
Turn-On DelayTime	td(on)		N-Channel: VGS=10V, VDS=6V, ID=5.2A, RL=1.2Ω, RGEN=1Ω P-Channel: VGS=-10V, VDS=-6V, ID=-3.8A, RL=1.6Ω, RGEN=1Ω	N-CH	5		10	ns
				P-CH	8		15	
Turn-On Rise Time	tr	N-CH		10	15			
		P-CH		12	20			
Turn-Off DelayTime	td(off)	N-CH		18	30			
		P-CH		25	40			
Turn-Off Fall Time	tf	N-CH		10	15			
		P-CH		18	30			
Body Diode Reverse Recovery Time	trr	N-Channel IF=5.2A, dI/dt = 100A/μs, TJ = 25 °C P-Channel IF= -3.8A, dI/dt = -100 A/μs, TJ = 25 °C		N-CH	20	40	nS	
				P-CH	30	60		
Body Diode Reverse Recovery Charge	Qrr		N-CH	5	10	nC		
			P-CH	12	24			
Reverse Recovery Fall Time	ta		N-CH	8		nS		
			P-CH	16				
Reverse Recovery Rise Time	tb		N-CH	12				
			P-CH	14				
Maximum Body-Diode Continuous Current	Is		Tc = 25 °C	N-CH	4.5	A		
				P-CH	-4.5			
Pulsed Body-Diode Current *	ISM	N-CH		20	A			
		P-CH		-10				
Diode Forward Voltage	VSD	Is=5.2A, VGS=0V		N-CH	1.2	V		
		Is=-3.4A, VGS=0V		P-CH	-1.2			

Note. Pulse test; pulse width ≤ 300 μs, duty cycle ≤ 2 %.

Complementary Trench MOSFET 2NP03

■ N-Channel Typical Characteristics

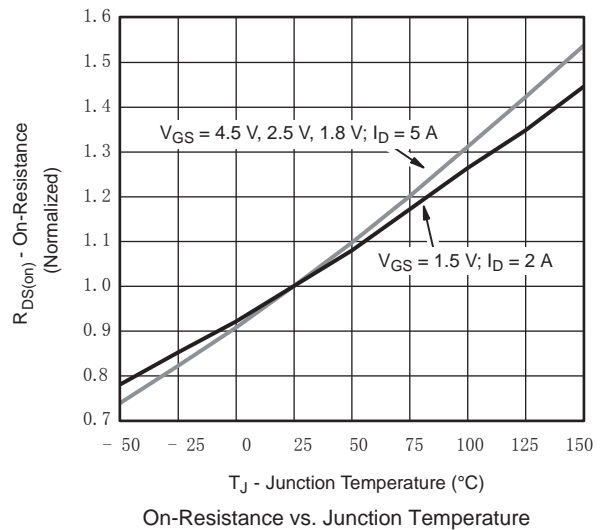
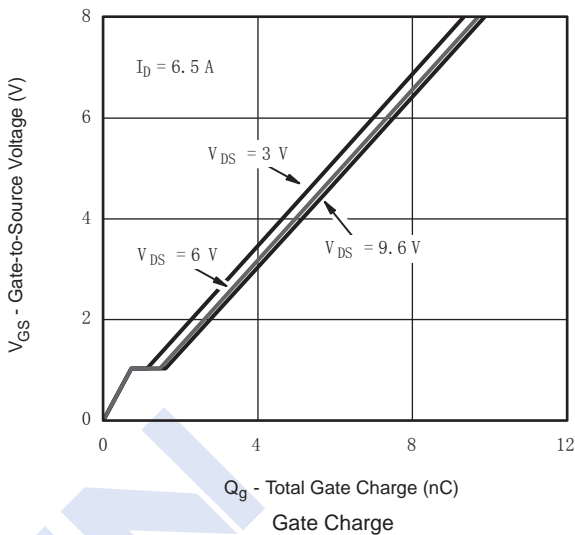
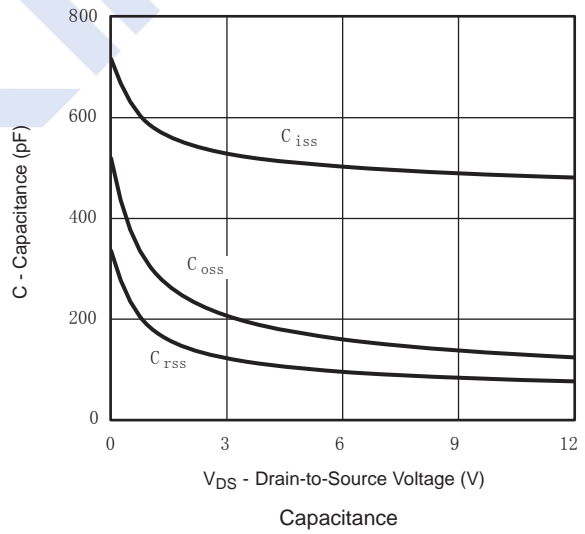
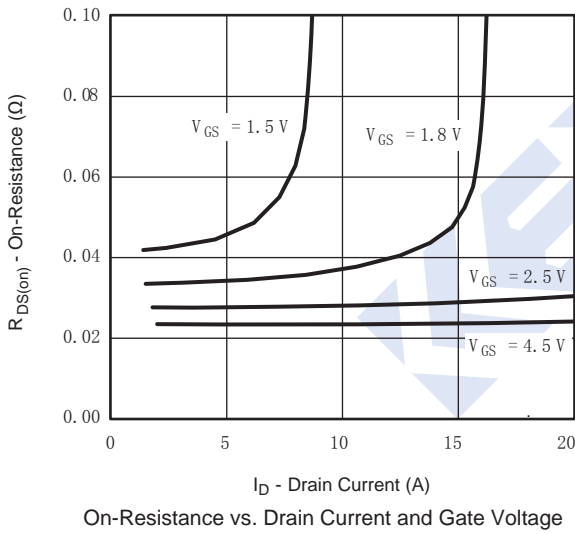
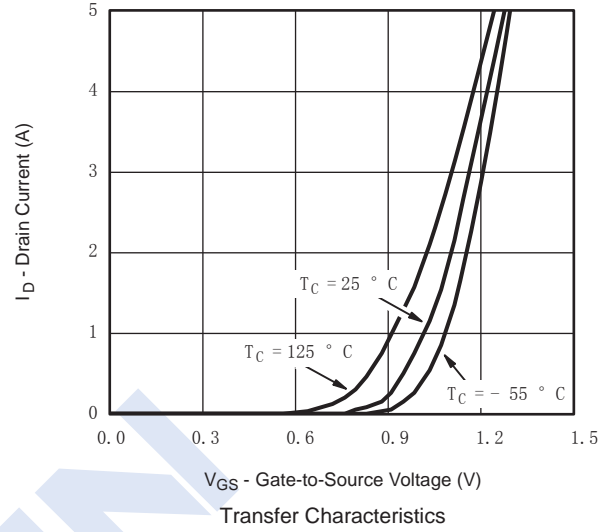
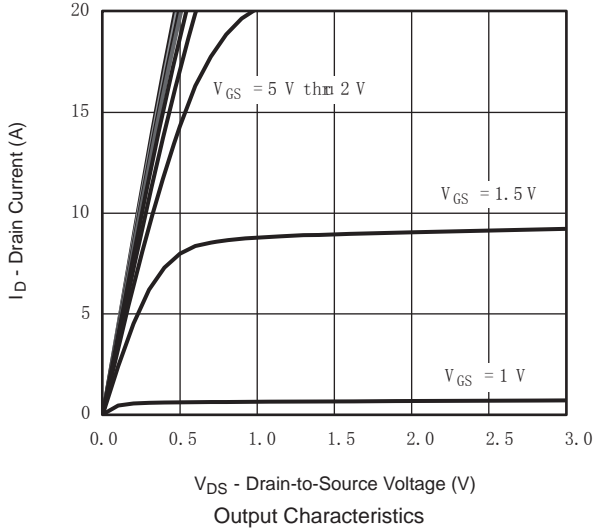

Complementary Trench MOSFET

2NP03

■ N-Channel Typical Characteristics

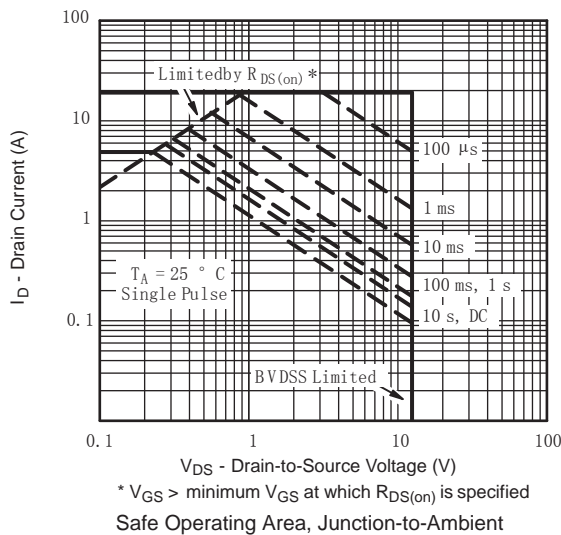
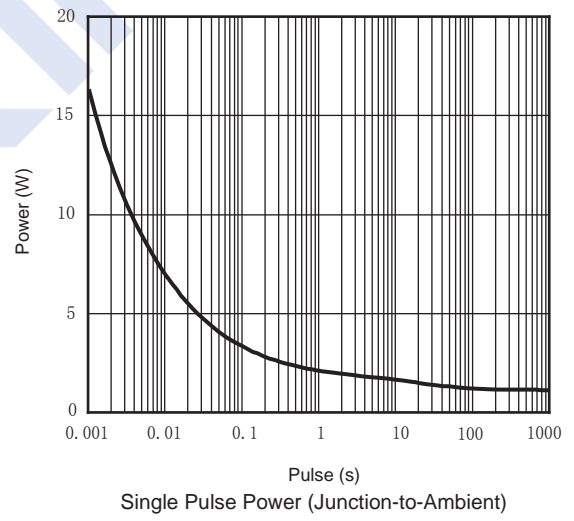
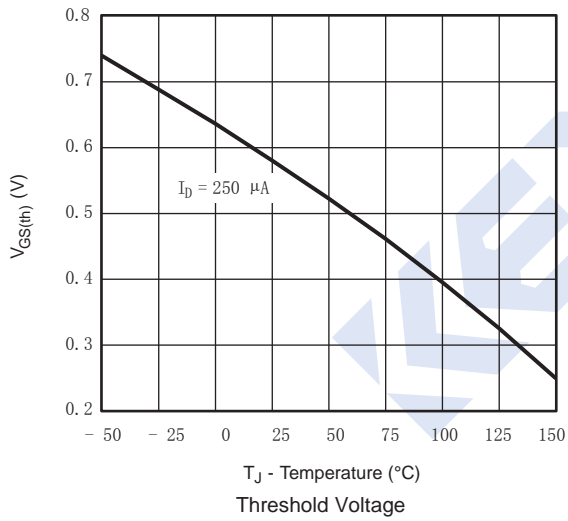
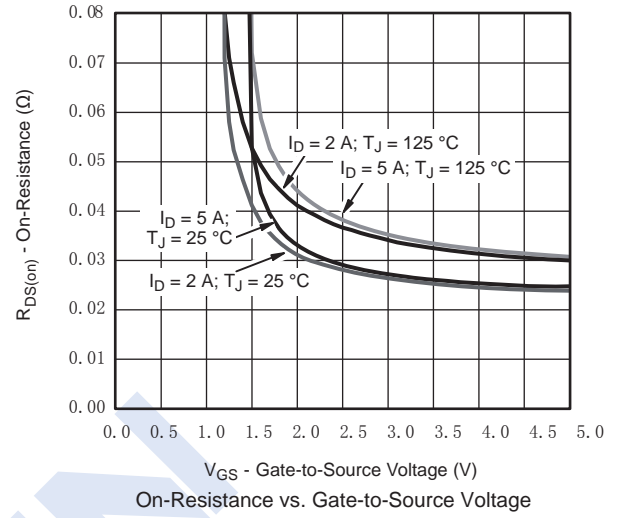
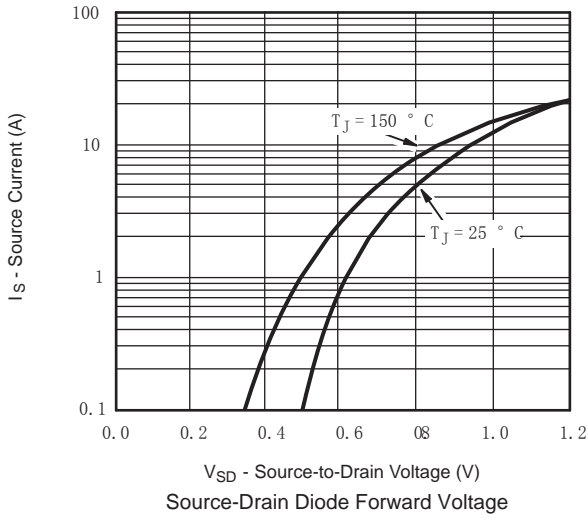

Complementary Trench MOSFET

2NP03

■ N-Channel Typical Characteristics

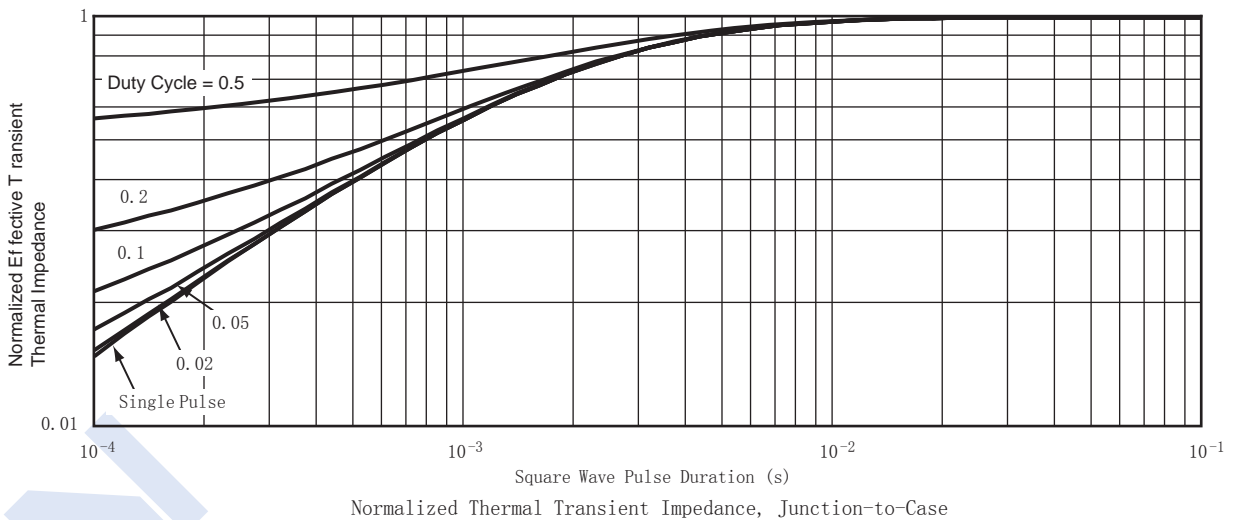
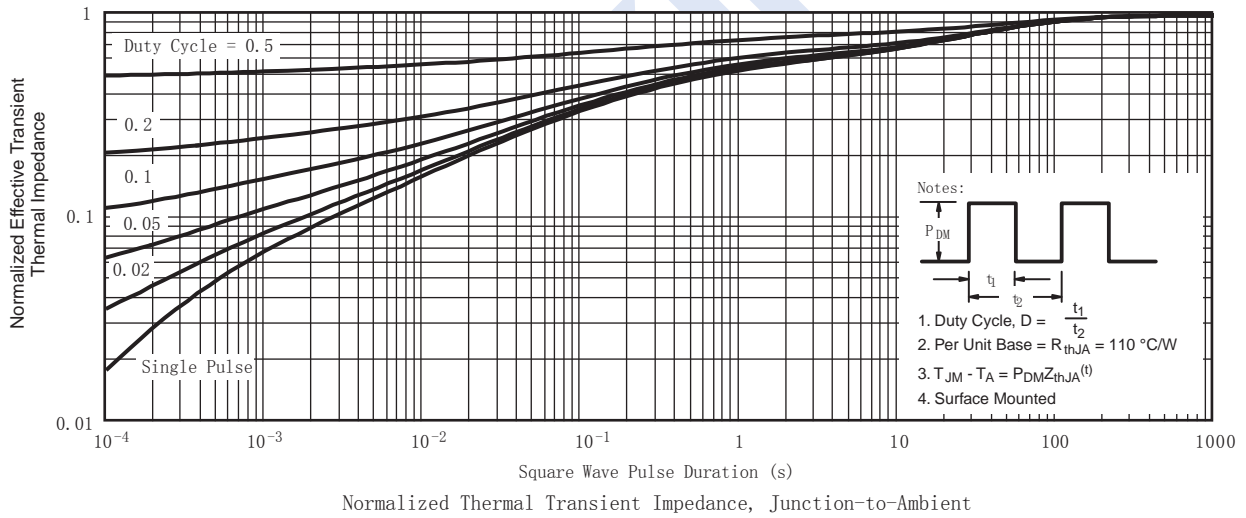
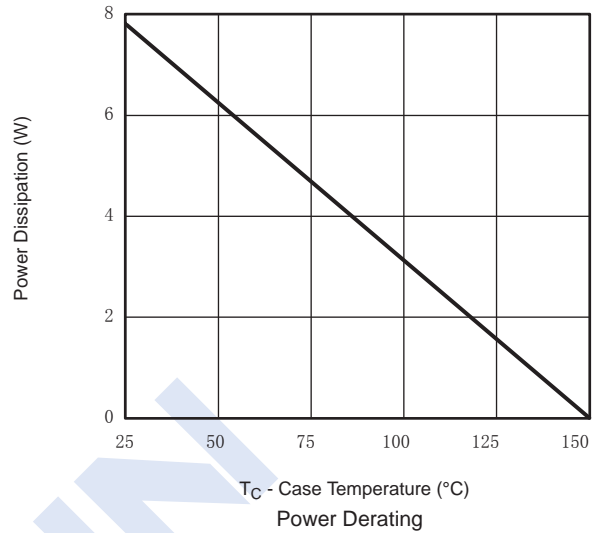
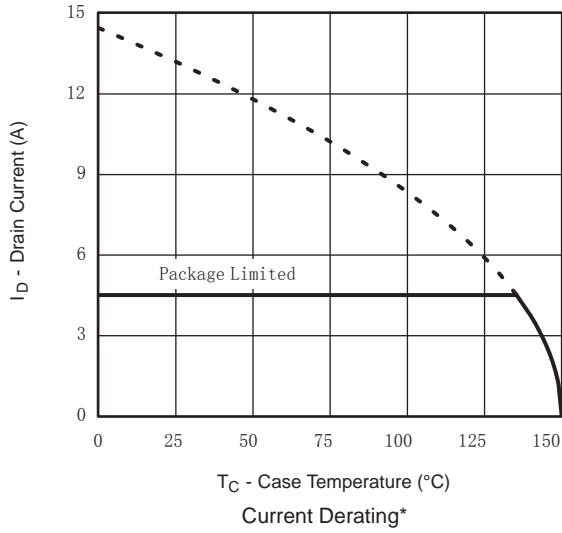

Complementary Trench MOSFET 2NP03

■ P-Channel Typical Characteristics

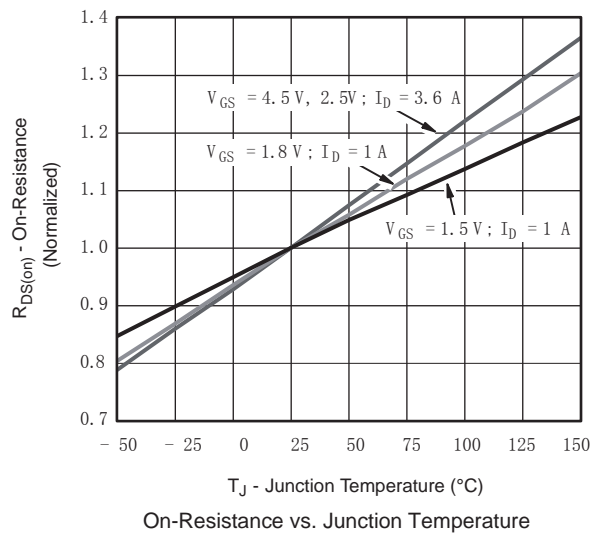
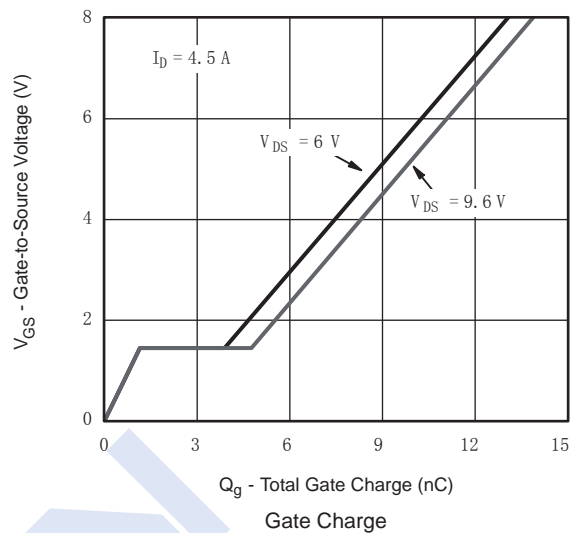
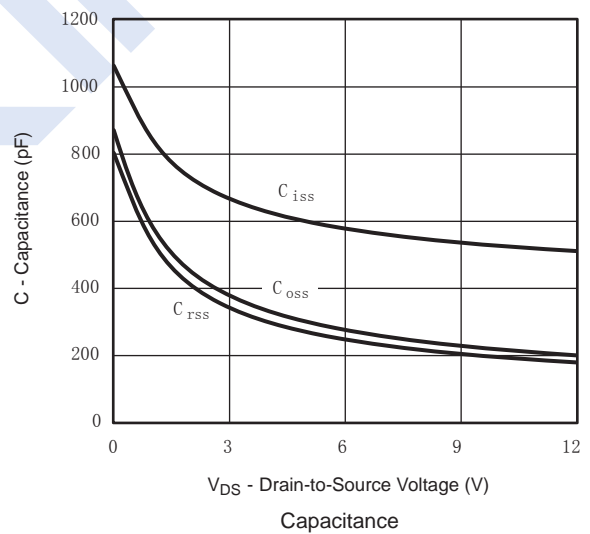
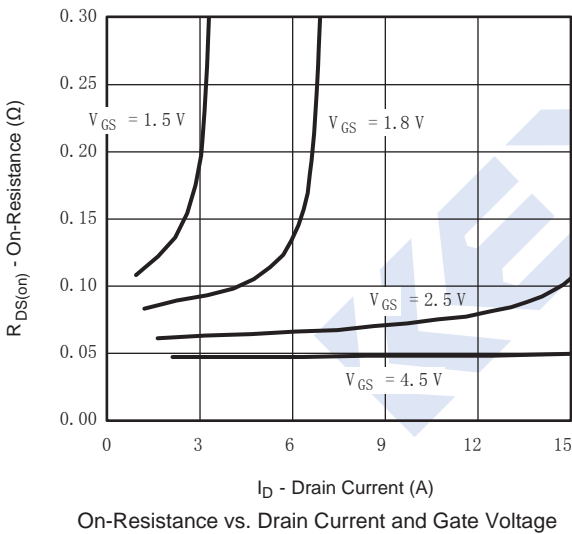
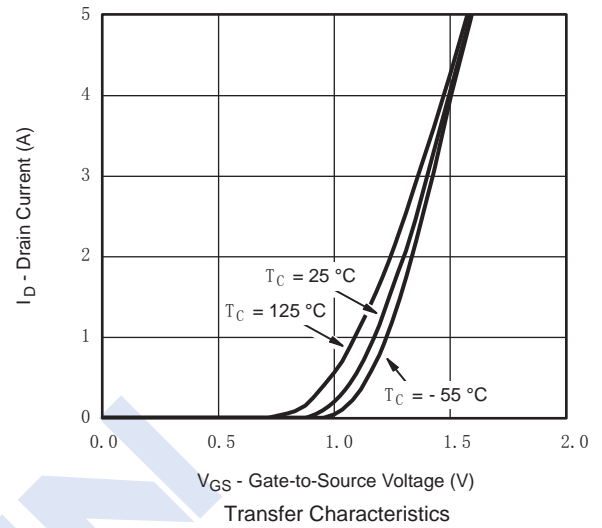
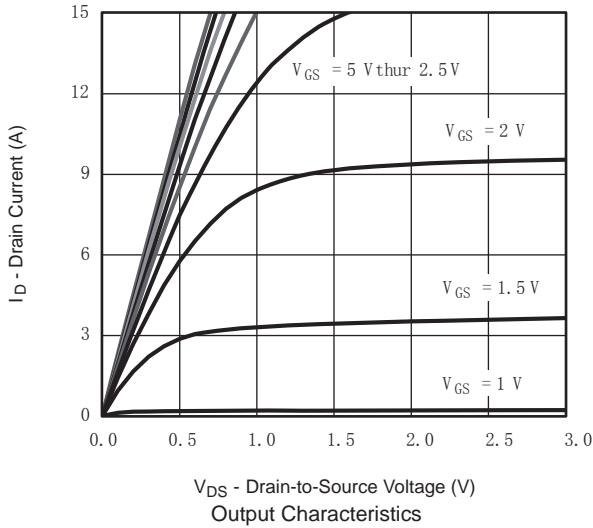

Complementary Trench MOSFET

2NP03

■ P-Channel Typical Characteristics

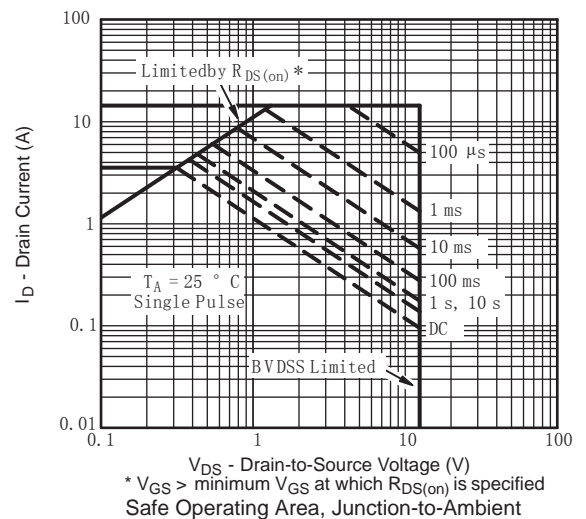
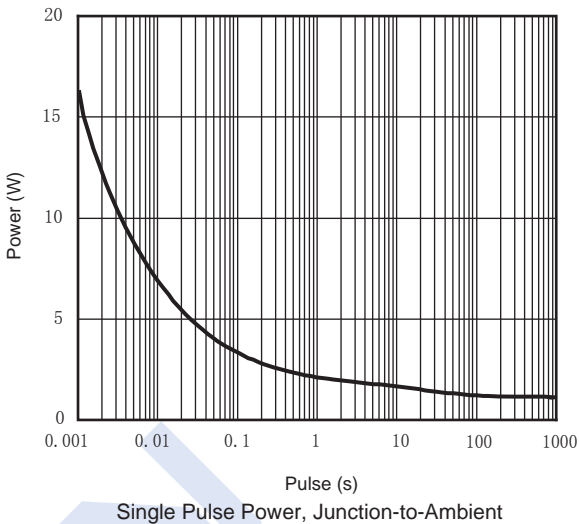
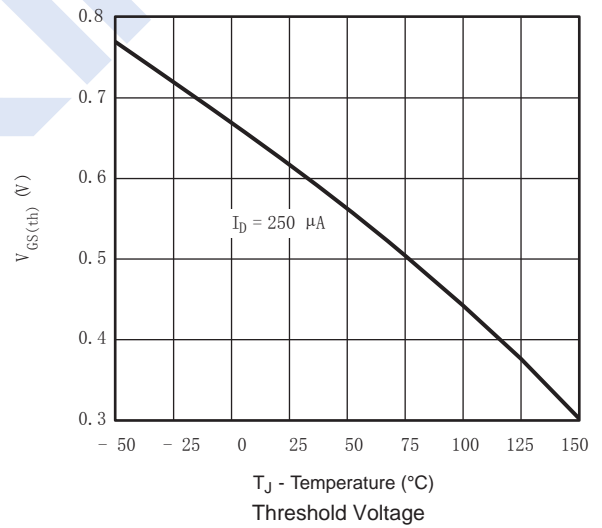
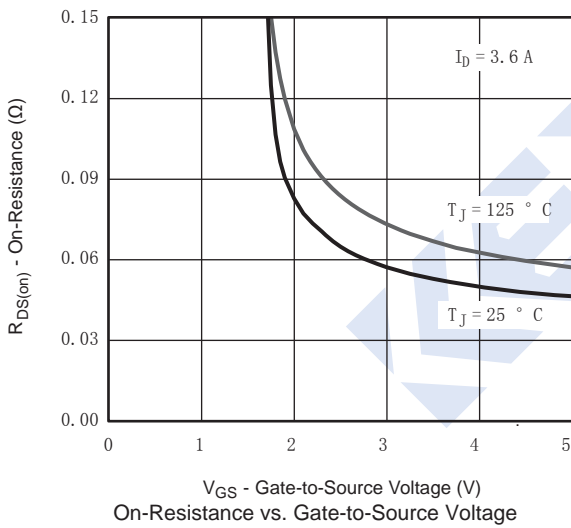
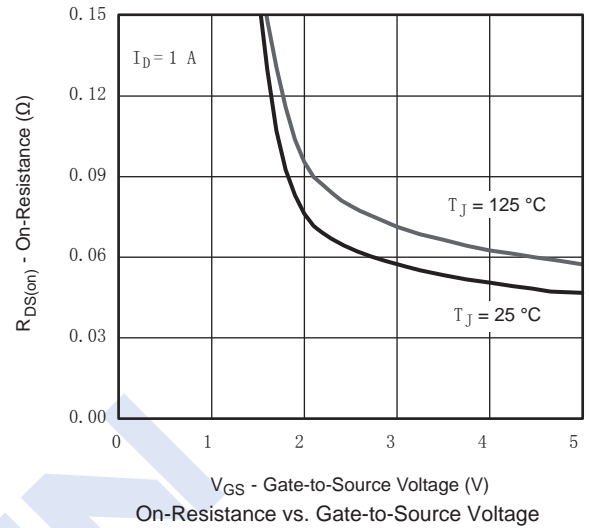
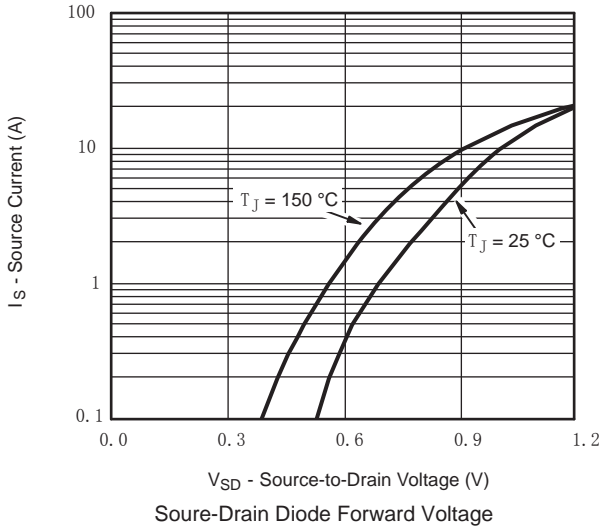

Complementary Trench MOSFET 2NP03

■ P-Channel Typical Characteristics

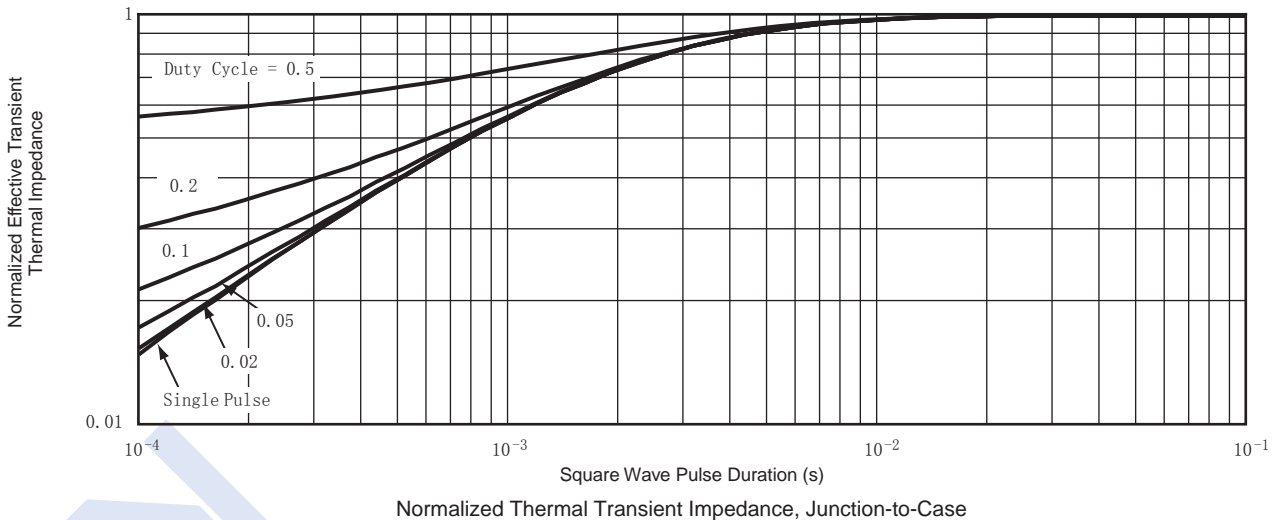
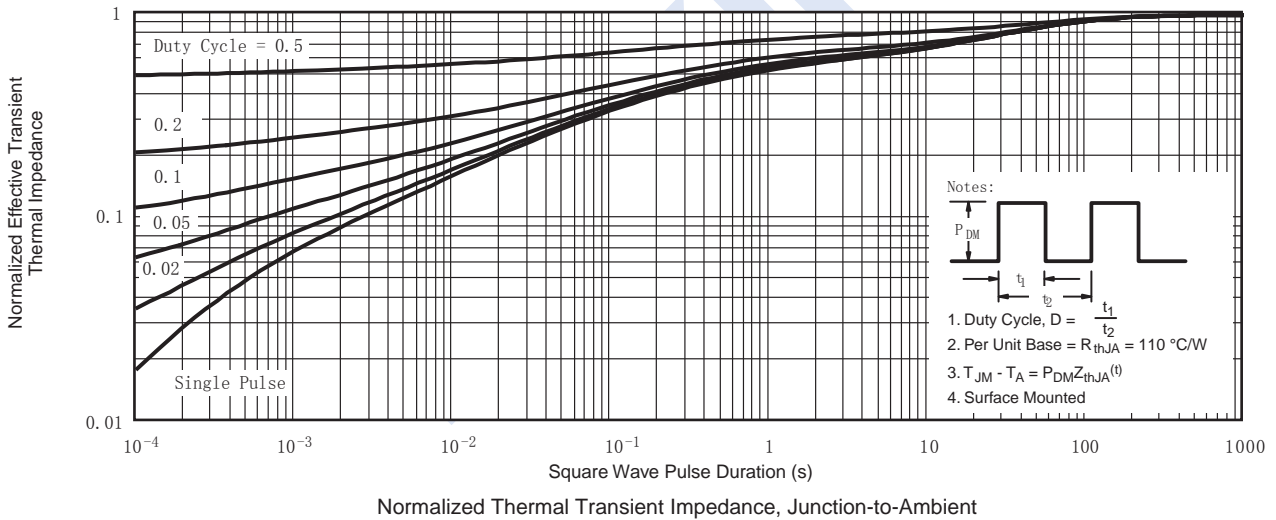
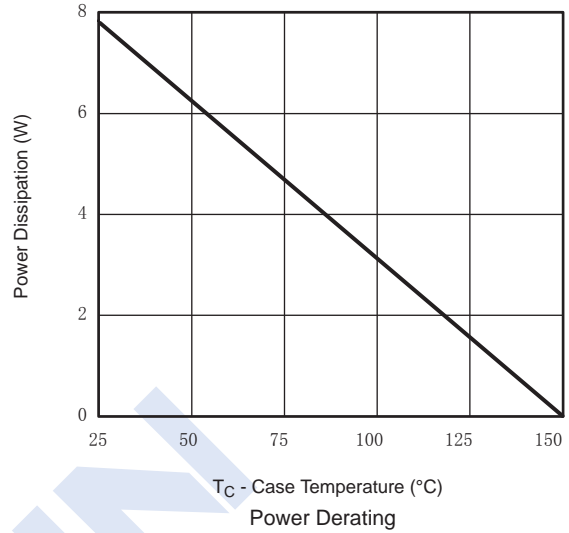
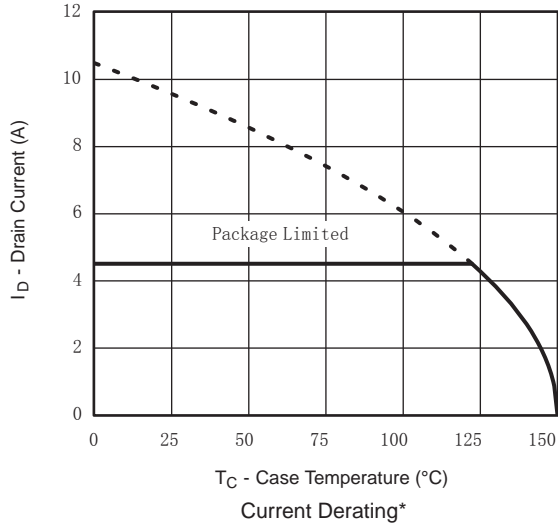

Plastic surface mounted package

DFN2X2-6L

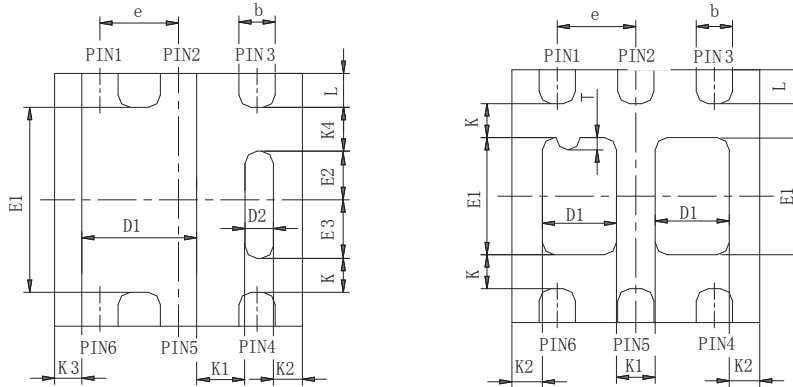

BACKSIDE VIEW OF SINGLE

BACKSIDE VIEW OF DUAL

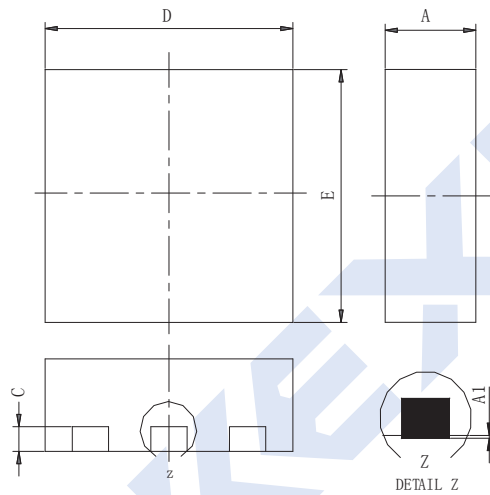

- Notes:
 1. All dimensions are in millimeters
 2. Package outline exclusive of mold flash and metal burr
 3. Package outline inclusive of plating

DIM	SINGLE PAD						DUAL PAD					
	MILLIMETERS			INCHES			MILLIMETERS			INCHES		
	Min	Nom	Max	Min	Nom	Max	Min	Nom	Max	Min	Nom	Max
A	0.675	0.75	0.80	0.027	0.030	0.032	0.675	0.75	0.80	0.027	0.030	0.032
A1	0	-	0.05	0	-	0.002	0	-	0.05	0	-	0.002
b	0.23	0.30	0.38	0.009	0.012	0.015	0.23	0.30	0.38	0.009	0.012	0.015
C	0.15	0.20	0.25	0.006	0.008	0.010	0.15	0.20	0.25	0.006	0.008	0.010
D	1.98	2.05	2.15	0.078	0.081	0.085	1.98	2.05	2.15	0.078	0.081	0.085
D1	0.85	0.95	1.05	0.033	0.037	0.041	0.513	0.613	0.713	0.020	0.024	0.028
D2	0.135	0.235	0.335	0.005	0.009	0.013						
E	1.98	2.05	2.15	0.078	0.081	0.085	1.98	2.05	2.15	0.078	0.081	0.085
E1	1.40	1.50	1.60	0.055	0.059	0.063	0.85	0.95	1.05	0.033	0.037	0.041
E2	0.345	0.395	0.445	0.014	0.016	0.018						
E3	0.425	0.475	0.525	0.017	0.019	0.021						
e	0.65 BSC			0.026 BSC			0.65 BSC			0.026 BSC		
K	0.275 TYP			0.011 TYP			0.275 TYP			0.011 TYP		
K1	0.400 TYP			0.016 TYP			0.320 TYP			0.013 TYP		
K2	0.240 TYP			0.009 TYP			0.252 TYP			0.010 TYP		
K3	0.225 TYP			0.009 TYP								
K4	0.355 TYP			0.014 TYP								
L	0.175	0.275	0.375	0.007	0.011	0.015	0.175	0.275	0.375	0.007	0.011	0.015
T							0.05	0.10	0.15	0.002	0.004	0.006