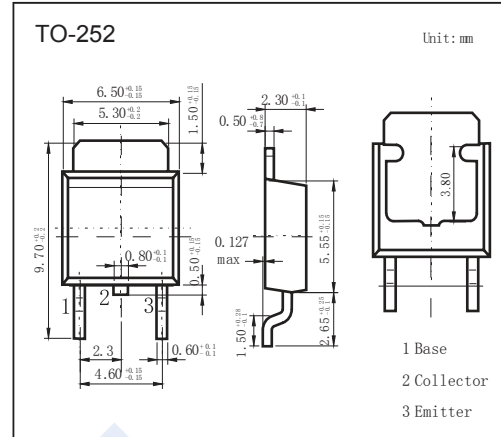

PNP Transistors

2SB1261-Z

■ Features

- High h_{FE} $h_{FE} = 100$ to 400
- Low $V_{CE(sat)}$ $V_{CE(sat)} \leq 0.3$ V

■ Absolute Maximum Ratings $T_a = 25^\circ\text{C}$

Parameter	Symbol	Rating	Unit
Collector - Base Voltage	V_{CB0}	-60	V
Collector - Emitter Voltage	V_{CE0}	-60	
Emitter - Base Voltage	V_{EB0}	-7	
Collector Current - Continuous	I_C	-3	A
Collector Current - Pulse	I_{CP}	-5	
Base Current	I_B	-0.5	
Collector Power Dissipation	P_C	$T_c = 25^\circ\text{C}$ 10	W
		$T_a = 25^\circ\text{C}$ 2	
Junction Temperature	T_J	150	$^\circ\text{C}$
Storage Temperature range	T_{stg}	-55 to 150	

■ Electrical Characteristics $T_a = 25^\circ\text{C}$

Parameter	Symbol	Test Conditions	Min	Typ	Max	Unit
Collector-base breakdown voltage	V_{CB0}	$I_C = -100 \mu\text{A}$, $I_E = 0$	-60			V
Collector-emitter breakdown voltage	V_{CE0}	$I_C = -1 \text{ mA}$, $I_B = 0$	-60			
Emitter-base breakdown voltage	V_{EB0}	$I_E = -100 \mu\text{A}$, $I_C = 0$	-7			
Collector-base cut-off current	I_{CBO}	$V_{CB} = -60\text{V}$, $I_E = 0$			-10	μA
Emitter cut-off current	I_{EBO}	$V_{EB} = -7\text{V}$, $I_C = 0$			-10	
Collector-emitter saturation voltage	$V_{CE(sat)}$	$I_C = -1.5 \text{ A}$, $I_B = -150 \text{ mA}$		-0.2	-0.3	V
Base-emitter saturation voltage	$V_{BE(sat)}$	$I_C = -1.5 \text{ A}$, $I_B = -150 \text{ mA}$		-0.94	-1.2	
DC current gain	h_{FE}	$V_{CE} = -2\text{V}$, $I_C = -200 \text{ mA}$	60			
		$V_{CE} = -2\text{V}$, $I_C = -600 \text{ mA}$	100		400	
		$V_{CE} = -2\text{V}$, $I_C = -2 \text{ A}$	50			
Turn-on time	t_{on}	$I_C = -1 \text{ A}$, $V_{CC} = -10\text{V}$, $R_L = 10\Omega$, $I_{B1} = -I_{B2} = -0.1 \text{ A}$		0.15	0.5	μs
Storage time	t_{stg}			0.5	2	
Fall time	t_f			0.1	0.5	
Collector output capacitance	C_{ob}	$V_{CB} = -10\text{V}$, $I_E = 0$, $f = 1\text{MHz}$		40		pF
Transition frequency	f_T	$V_{CE} = -5\text{V}$, $I_E = 1.5 \text{ A}$		50		MHz

■ Classification of $h_{FE}(2)$

Type	2SB1261-Z-M	2SB1261-Z-L	2SB1261-Z-K
Range	100-200	160-320	200-400

PNP Transistors

2SB1261-Z

■ Typical Characteristics

TOTAL POWER DISSIPATION vs. AMBIENT TEMPERATURE

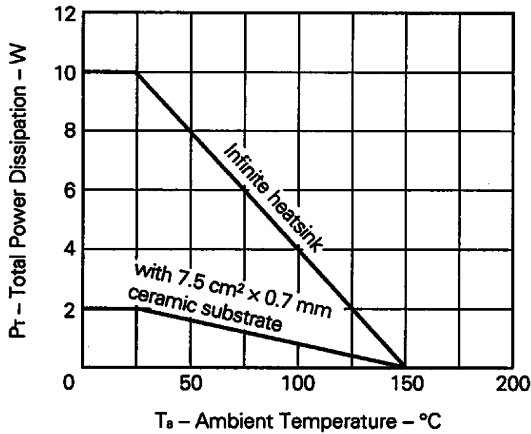

FORWARD BIAS SAFE OPERATING AREA

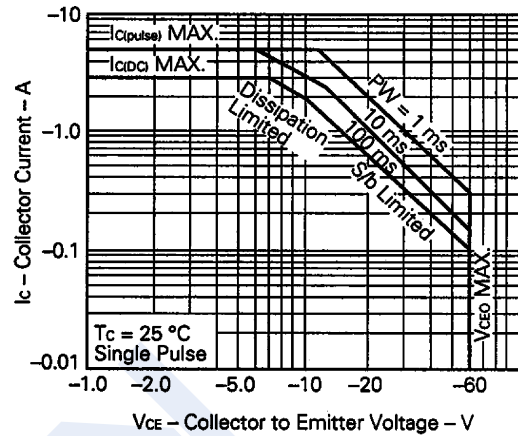

DERATING CURVE OF SAFE OPERATING AREA

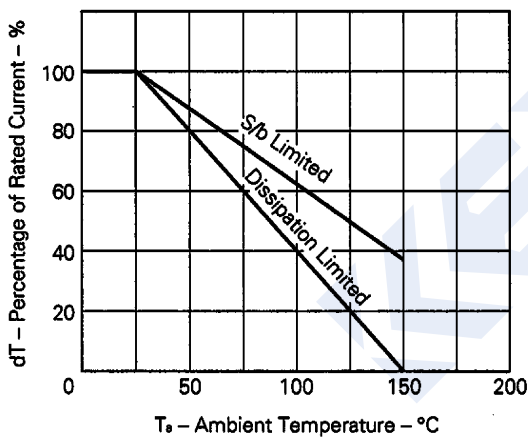

RESERVE BIAS SAFE OPERATING AREA

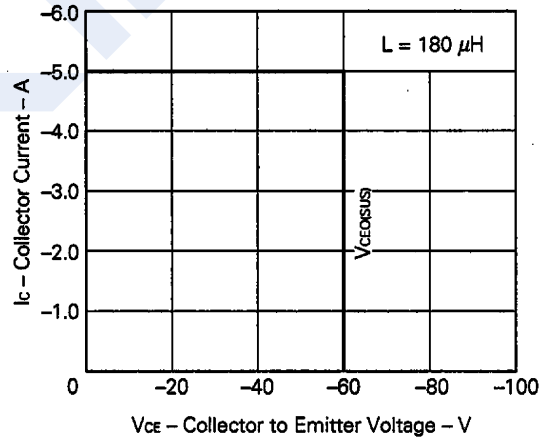

COLLECTOR CURRENT vs. COLLECTOR TO EMITTER VOLTAGE

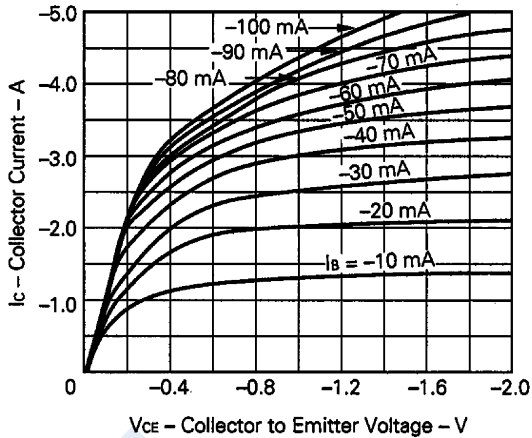

COLLECTOR CURRENT vs. COLLECTOR TO EMITTER VOLTAGE

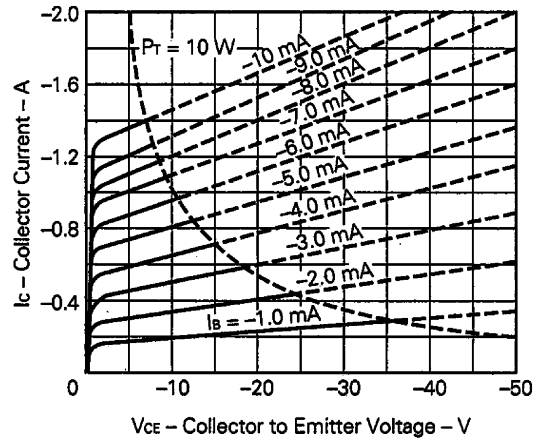

PNP Transistors

2SB1261-Z

■ Typical Characteristics

