

## Triacs

### BT139B series

#### ■ Features

- RMS on-state current :  $I_{T(RMS)}=16A$
- Non-repetitive peak on-state current:  $I_{TSM}=140A$

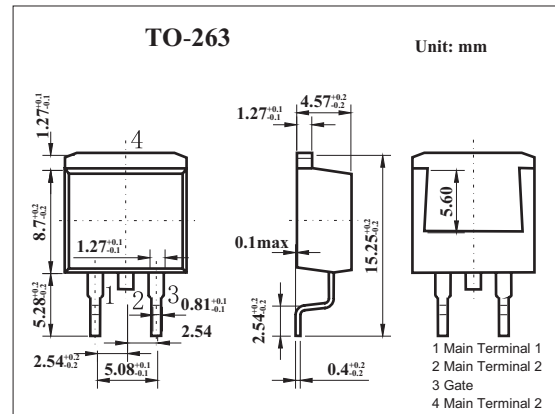
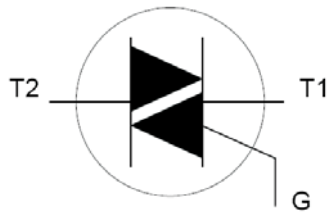

#### ■ Absolute Maximum Ratings $T_a = 25^\circ C$

Parameter	Symbol	BT139B series			Unit
		-500	-600	-800	
Peak Repetitive Off-State Voltage	$V_{DRM}, V_{RRM}$	500	600	800	V
On-State RMS Current	$I_{T(RMS)}$	16			A
Peak Non-Repetitive Surge Current	$I_{TSM}$	140			A
$t = 20 \text{ ms}$					
$t = 16.7 \text{ ms}$		150			
Circuit Fusing Consideration	$I^2t$	98			$A^2s$
Repetitive rate of rise of on-state current after triggering *1	$di_T/dt$	50			$A/\mu s$
T2+ G+					
T2+ G-					
T2- G-					
		10			$A/\mu s$
		10			$A/\mu s$
Peak Gate Current	$I_{GM}$	2			A
Peak Gate Voltage	$V_{GM}$	5			V
Peak Gate Power	$P_{GM}$	5			W
Average Gate Power	$P_{G(AV)}$	0.5			W
Operating Junction Temperature Range	$T_J$	125			$^\circ C$
Storage Temperature Range	$T_{stg}$	-40 to 150			$^\circ C$

\*1  $I_{TM} = 20 \text{ A}$ ;  $I_G = 0.2 \text{ A}$ ;  $di_G/dt = 0.2 \text{ A}/\mu s$

## BT139B series

## ■ Static Characteristics Ta = 25 °C

Parameter	Symbol	Testconditons BT139B...	Min	Typ	Max			Unit
					...	...F	...G	
Gate Trigger Current (Continuous dc) MT2+, G+ MT2+, G- MT2-, G- MT2-, G+	I <sub>GT</sub>	V <sub>D</sub> = 12 V, I <sub>T</sub> = 0.1 A		5 8 10 22	35 35 35 70	25 25 25 70	50 50 50 100	mA
Latching Current MT2+, G+ MT2+, G- MT2-, G- MT2-, G+	I <sub>L</sub>	V <sub>D</sub> = 12 V, I <sub>G</sub> = 0.1 A		7 20 8 10	40 60 40 60	40 60 40 60	60 90 60 90	mA
Holding Current	I <sub>H</sub>	V <sub>D</sub> = 12 V, I <sub>GT</sub> = 0.1 A		6	30	30	60	
On-state voltage	V <sub>T</sub>	I <sub>T</sub> = 20 A		1.2	1.6			V
Gate Trigger Voltage	V <sub>GT</sub>	V <sub>D</sub> = 12 V; I <sub>T</sub> = 0.1 A V <sub>D</sub> = 400 V; I <sub>T</sub> = 0.1 A, T <sub>j</sub> = 125 °C	0.25	0.7 0.4	1.5			V V
Off-state leakage current	I <sub>D</sub>	V <sub>D</sub> = V <sub>DRM(max)</sub> ; T <sub>j</sub> = 125 °C		0.1	0.5			mA

## ■ Dynamic Characteristics Ta = 25 °C

Parameter	Symbol	Testconditons BT139B...	Min			Typ	Max	Unit
			...	...F	...G			
Critical rate of rise of off-state voltage	dV <sub>D</sub> /dt	V <sub>DM</sub> = 67% V <sub>DRM(max)</sub> ; T <sub>j</sub> = 125 °C; exponential waveform; gate open circuit	100	50	200	250		V/μs
Critical rate of change of commutating voltage	dV <sub>com</sub> /dt	V <sub>DM</sub> = 400 V; T <sub>j</sub> = 95 °C; I <sub>T(RMS)</sub> = 16 A; di <sub>com</sub> /dt = 7.2 A/ms; gate open circuit			10	20		V/μs
Gate controlled turn-on time	t <sub>gt</sub>	I <sub>TM</sub> = 20 A; V <sub>D</sub> = V <sub>DRM(max)</sub> ; I <sub>G</sub> = 0.1 A; di <sub>G</sub> /dt = 5 A/μs						μs

BT139B series

■ Typical Characteristics

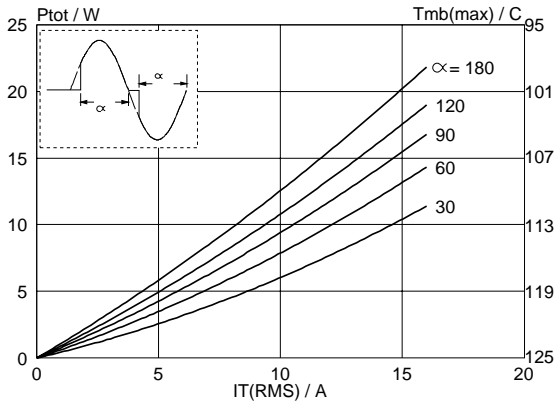

Fig.1. Maximum on-state dissipation,  $P_{tot}$ , versus rms on-state current,  $I_{T(RMS)}$ , where  $\alpha$  = conduction angle.

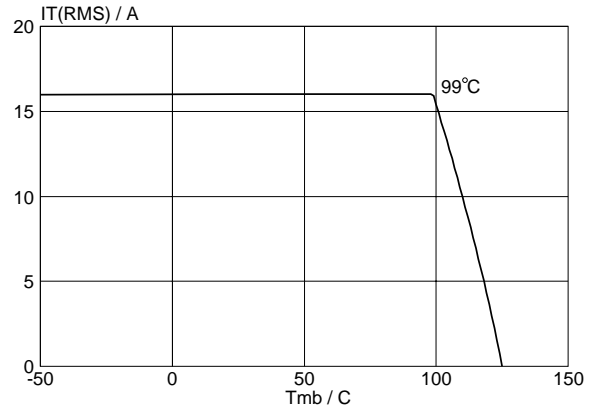

Fig.4. Maximum permissible rms current  $I_{T(RMS)}$ , versus mounting base temperature  $T_{mb}$ .

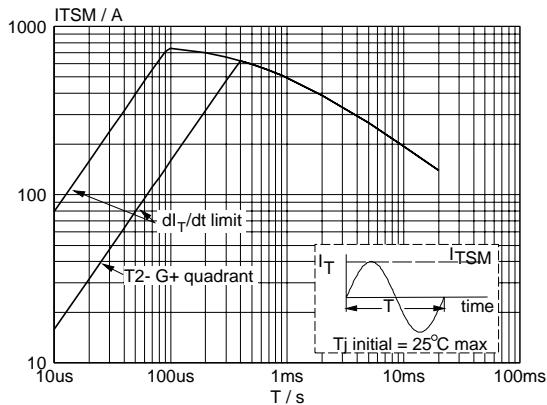

Fig.2. Maximum permissible non-repetitive peak on-state current  $I_{TSM}$ , versus pulse width  $t_p$ , for sinusoidal currents,  $t_p \leq 20ms$ .

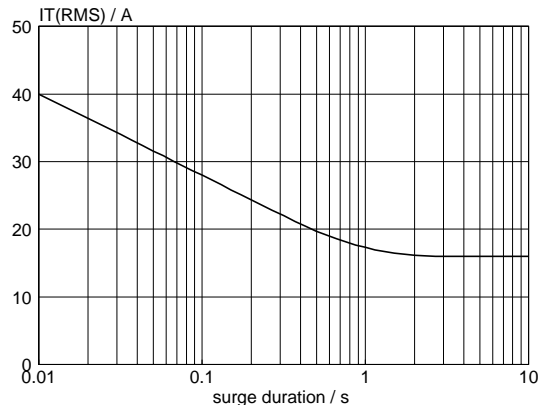

Fig.5. Maximum permissible repetitive rms on-state current  $I_{T(RMS)}$ , versus surge duration, for sinusoidal currents,  $f = 50$  Hz;  $T_{mb} \leq 99^\circ\text{C}$ .

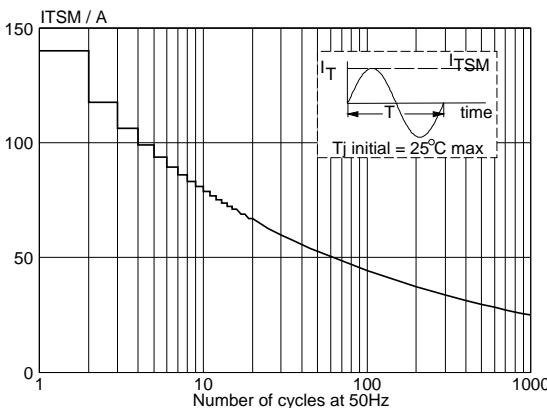

Fig.3. Maximum permissible non-repetitive peak on-state current  $I_{TSM}$ , versus number of cycles, for sinusoidal currents,  $f = 50$  Hz.

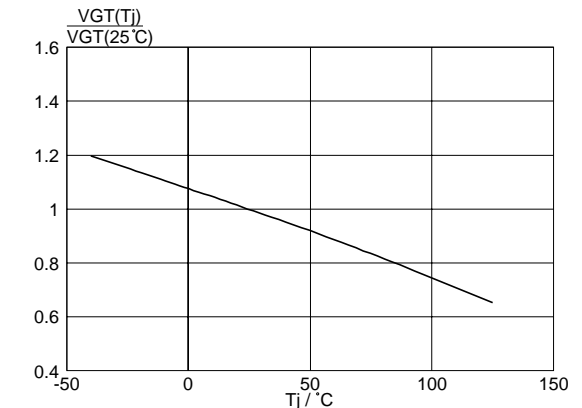

Fig.6. Normalised gate trigger voltage  $V_{GT}(T_j) / V_{GT}(25^\circ\text{C})$ , versus junction temperature  $T_j$ .

BT139B series

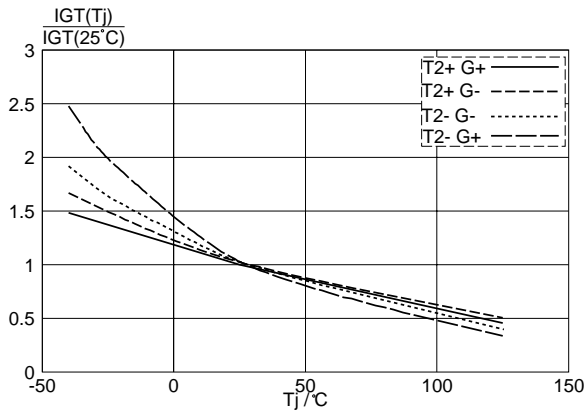

Fig.7. Normalised gate trigger current  $I_{GT}(T_j) / I_{GT}(25^\circ\text{C})$ , versus junction temperature  $T_j$ .

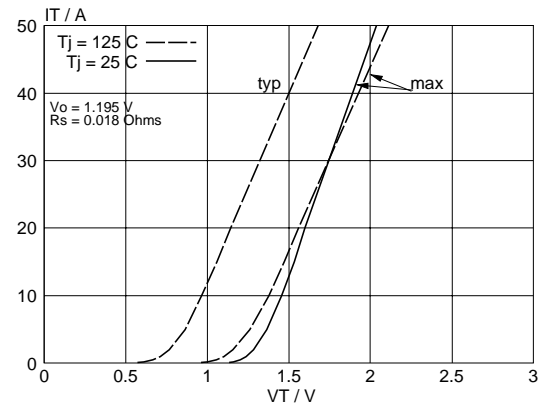

Fig.10. Typical and maximum on-state characteristic.

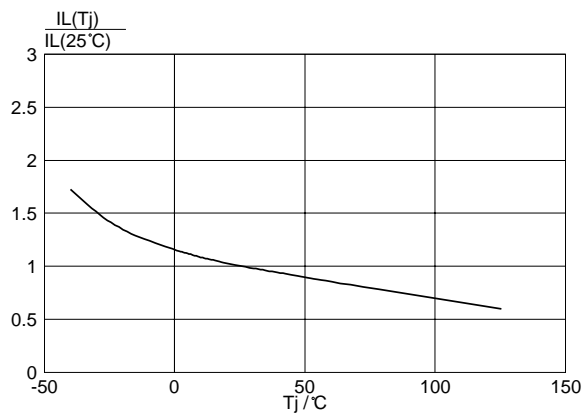

Fig.8. Normalised latching current  $I_L(T_j) / I_L(25^\circ\text{C})$ , versus junction temperature  $T_j$ .

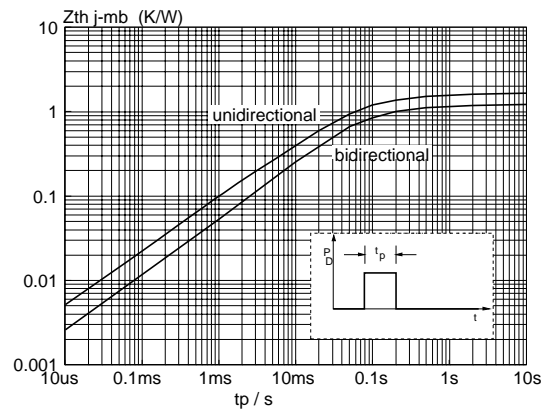

Fig.11. Transient thermal impedance  $Z_{th\ j-mb}$ , versus pulse width  $t_p$ .

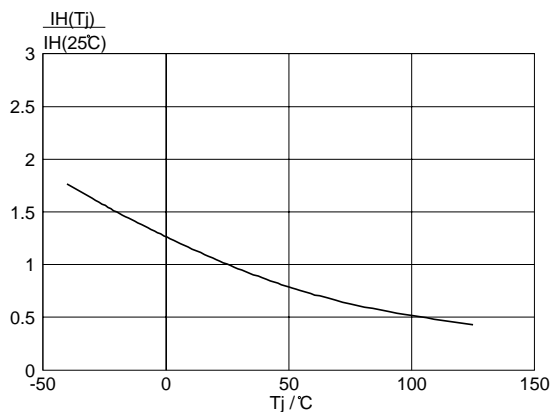

Fig.9. Normalised holding current  $I_H(T_j) / I_H(25^\circ\text{C})$ , versus junction temperature  $T_j$ .

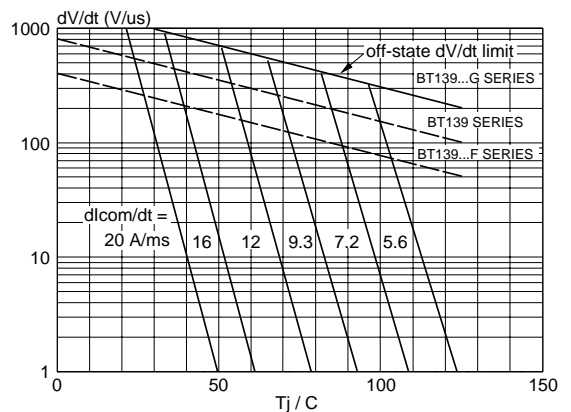

Fig.12. Typical commutation  $dV/dt$  versus junction temperature, parameter commutation  $di_T/dt$ . The triac should commute when the  $dV/dt$  is below the value on the appropriate curve for pre-commutation  $di_T/dt$ .