

P-Channel MOSFET

KX5P04DY

■ Features

- $V_{DS} (V) = -40V$
- $I_D = -5.3 A (V_{GS} = -10V)$
- $R_{DS(ON)} < 80m\Omega (V_{GS} = -10V)$
- $R_{DS(ON)} < 120m\Omega (V_{GS} = -4.5V)$

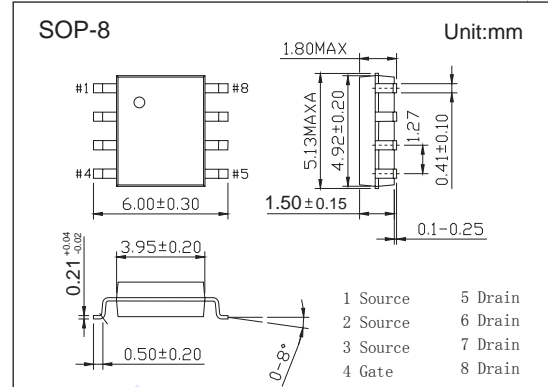

■ Absolute Maximum Ratings $T_a = 25^\circ C$

Parameter	Symbol	Rating	Unit
Drain-Source Voltage	V_{DS}	-40	V
Gate-Source Voltage	V_{GS}	± 20	
Continuous Drain Current	I_D	-5.3	A
Power Dissipation	P_D	2	W
Junction Temperature	T_J	150	$^\circ C$
Junction Storage Temperature Range	T_{stg}	-55 to 150	

■ Electrical Characteristics $T_a = 25^\circ C$

Parameter	Symbol	Test Conditions	Min	Typ	Max	Unit
Drain-Source Breakdown Voltage	V_{DSS}	$I_D = -250 \mu A, V_{GS} = 0V$	-40			V
Zero Gate Voltage Drain Current	I_{DSS}	$V_{DS} = -40V, V_{GS} = 0V$			-1	μA
Gate-Body leakage current	I_{GSS}	$V_{DS} = 0V, V_{GS} = \pm 20V$			± 100	nA
Gate Threshold Voltage	$V_{GS(th)}$	$V_{DS} = V_{GS}, I_D = -250 \mu A$	-1		-3	V
Static Drain-Source On-Resistance	$R_{DS(on)}$	$V_{GS} = -10V, I_D = -5A$			80	m Ω
		$V_{GS} = -4.5V, I_D = -4A$			120	

■ Marking

Marking	4005
---------	------

P-Channel MOSFET KX5P04DY

■ Typical Characteristics

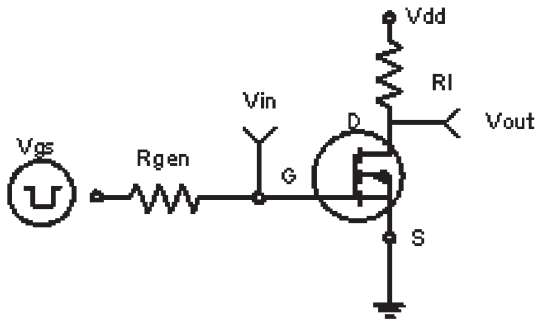

Figure 1: Switching Test Circuit

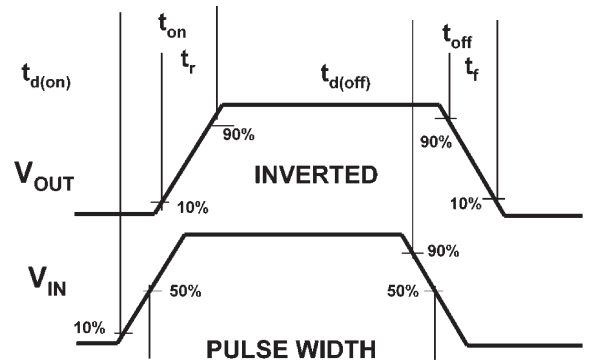

Figure 2: Switching Waveforms

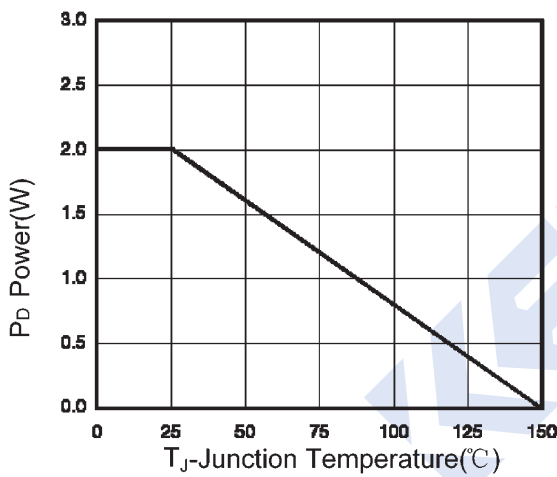

Figure 3 Power Dissipation

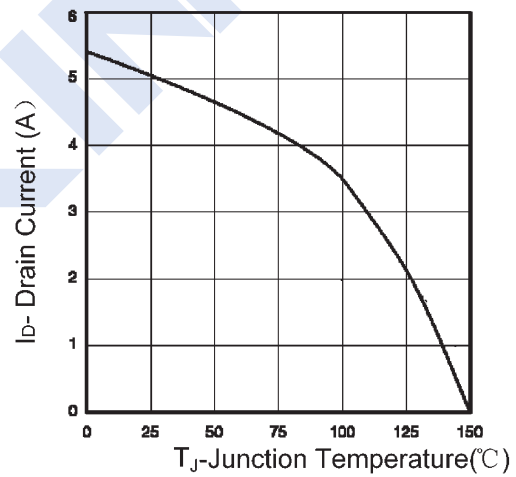

Figure 4 Drain Current

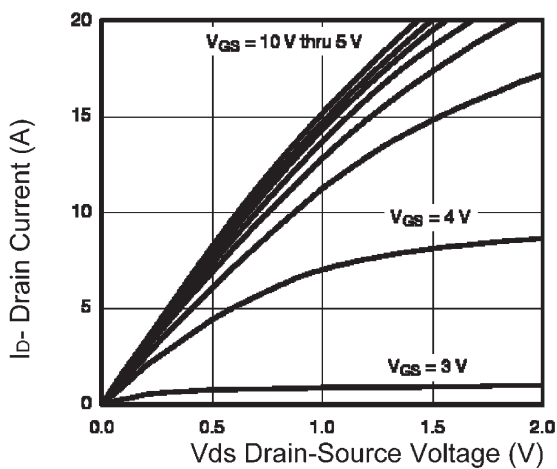

Figure 5 Output Characteristics

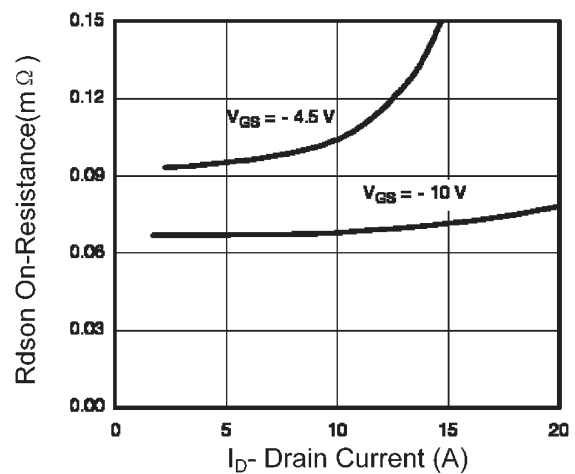

Figure 6 Drain-Source On-Resistance

P-Channel MOSFET KX5P04DY

■ Typical Characteristics

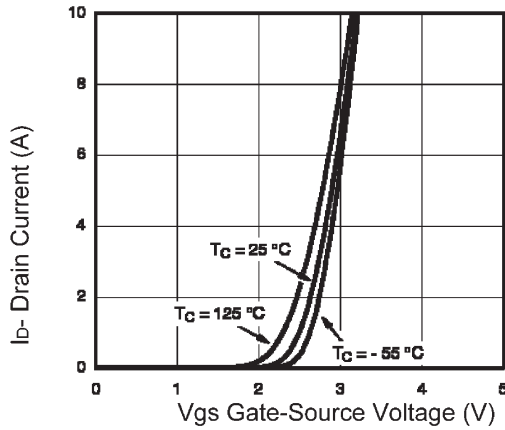

Figure 7 Transfer Characteristics

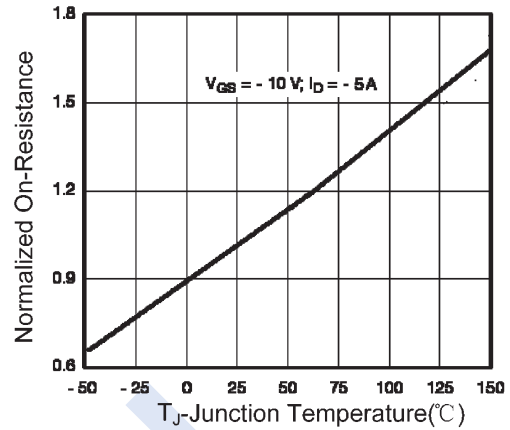

Figure 8 Drain-Source On-Resistance

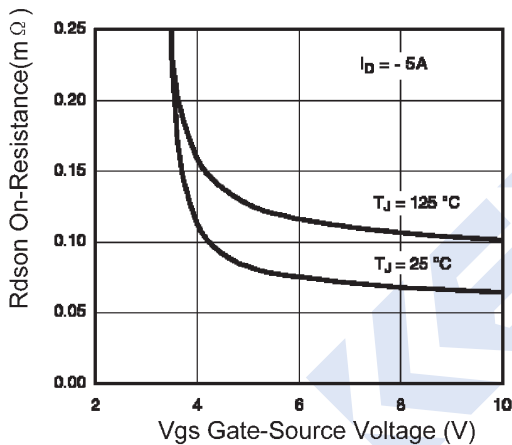

Figure 9 Rdson vs Vgs

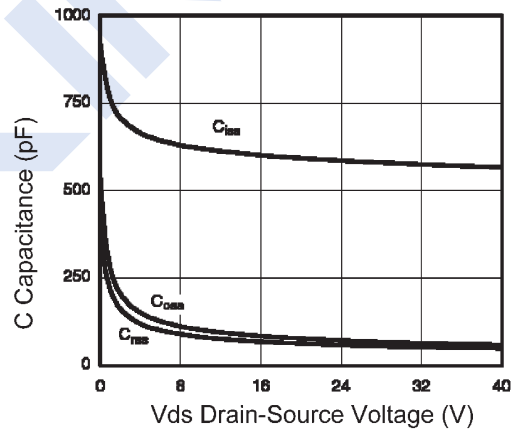

Figure 10 Capacitance vs Vds

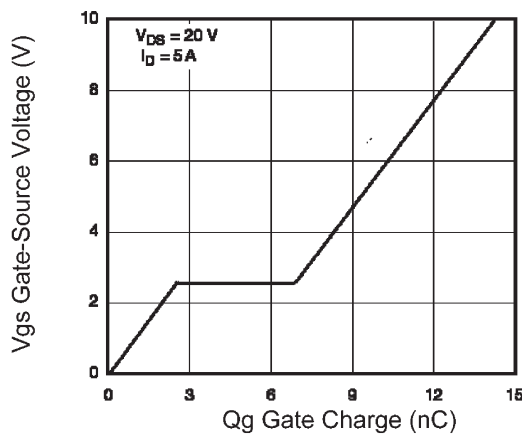

Figure 11 Gate Charge

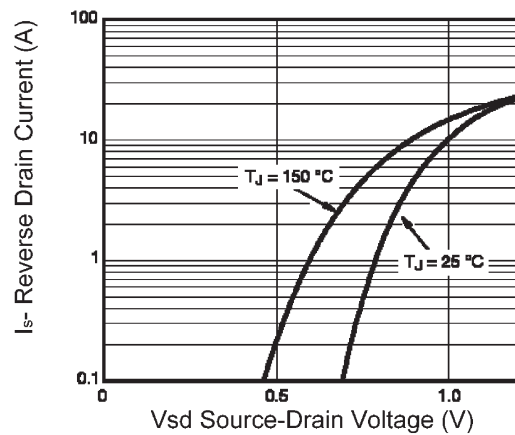

Figure 12 Source-Drain Diode Forward

P-Channel MOSFET KX5P04DY

■ Typical Characteristics

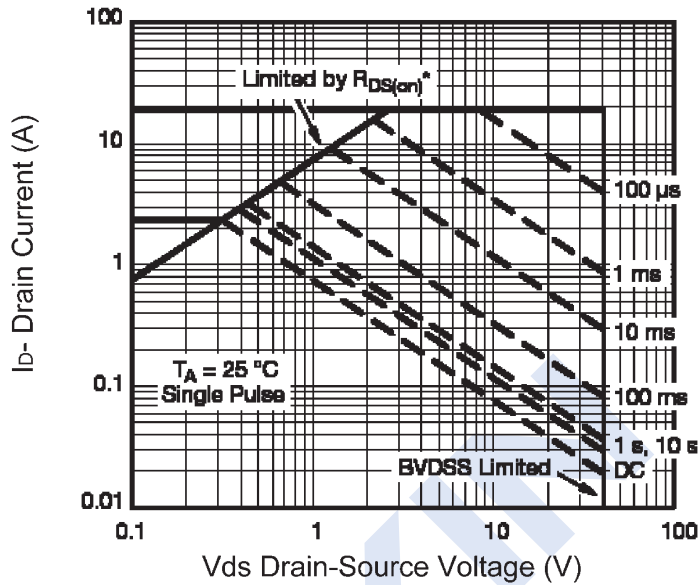

Figure 13 Safe Operation Area

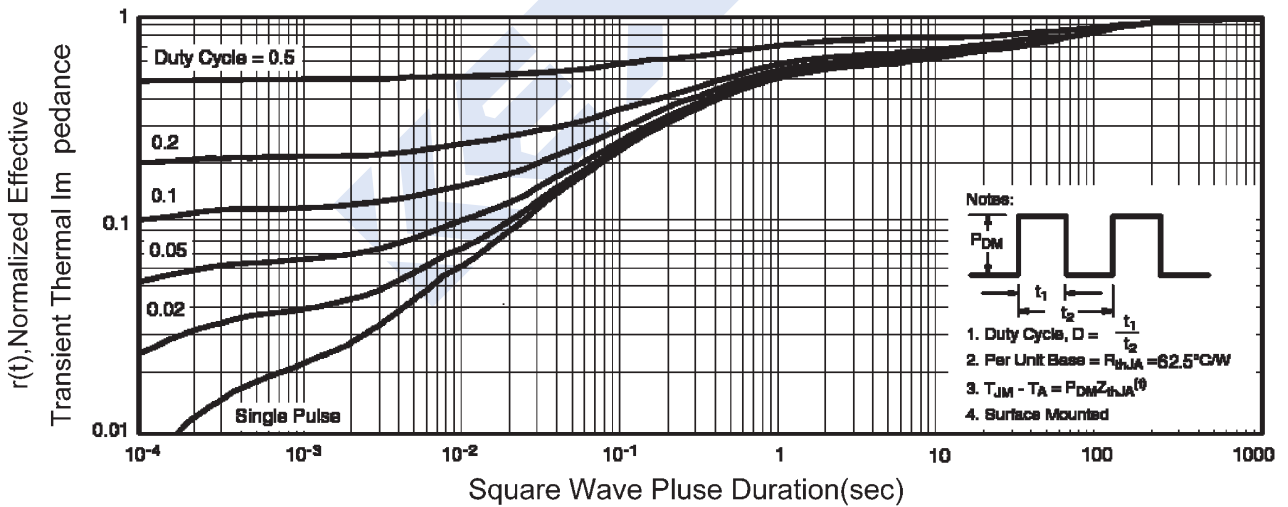

Figure 14 Normalized Maximum Transient Thermal Impedance