

## Small Surface Mount Fast Recovery Rectifiers

## RS207FL

## ■ Features

- For surface mounted applications
- Low profile package
- Ideal for automated placement
- Glass passivated chip junction
- High temperature soldering :  
260°C/ 10 seconds at terminals

## SOD-123FL

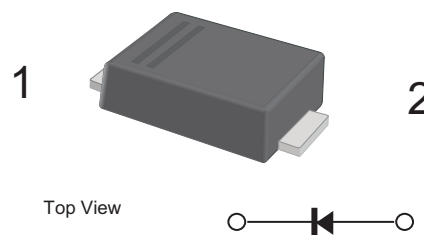

## PINNING

PIN	DESCRIPTION
1	Cathode
2	Anode

## ■ Absolute Maximum Ratings and Electrical Characteristics

Ratings at 25°C ambient temperature unless otherwise specified

Single phase half wave 60 HZ, resistive or inductive load For capacitive load, derate current by 20%

Parameter	Symbol	Value	Unit
Maximum Repetitive Peak Reverse Voltage	$V_{RRM}$	1000	V
Maximum RMS Voltage	$V_{RMS}$	700	
Maximum DC Blocking Voltage	$V_{DC}$	1000	
Maximum Instantaneous Forward Voltage (at $I_F=2A$ )	$V_F$	1.3	A
Maximum Averaged Forward Rectified Current	$I_{FAV}$	2.0	
Peak forward surge current, 8.3 ms Single Half Sine-wave Superimposed on Rated Load (JEDEC Method)	$I_{FSM}$	60	μA
Maximum DC Reverse Current at rated DC blocking voltage	$I_R$	5	
		50	
Reverse Recovery Time	$t_{rr}$	500	ns
Typical Junction Capacitance	$C_j$	9	pF
Typical thermal resistance	$R_{thJA}$	180	°C/W
Junction Temperature	$T_j$	150	°C
Storage Temperature	$T_{stg}$	-55 to 150	

\* 1 Reverse recovery condition  $I_F = 0.5 A$ ,  $I_R = 1 A$ ,  $I_{rr} = 0.25 A$

\* 2 Measured at 1MHz and applied reverse voltage of 4V D.C

\* 3 Thermal resistance from junction to ambient.

# Small Surface Mount Fast Recovery Rectifiers

## RS207FL

■ Typical Characteristics

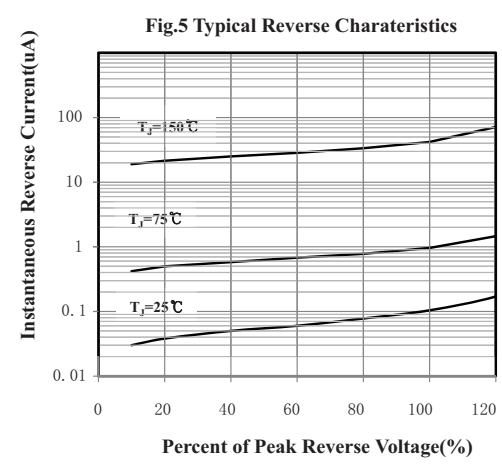
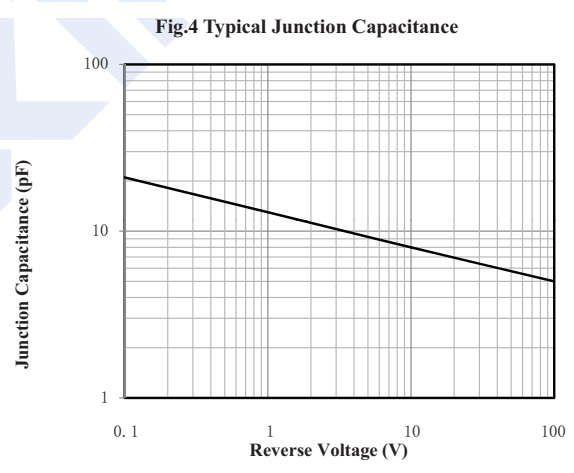
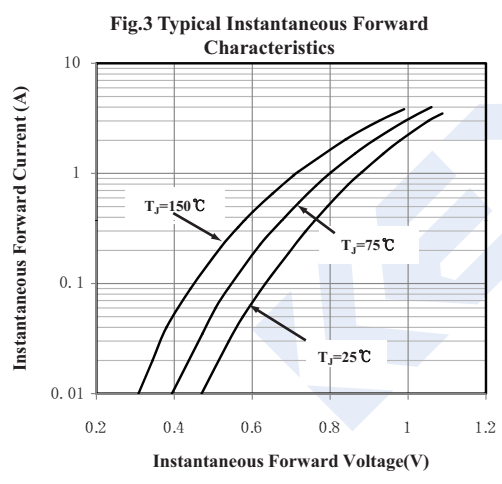
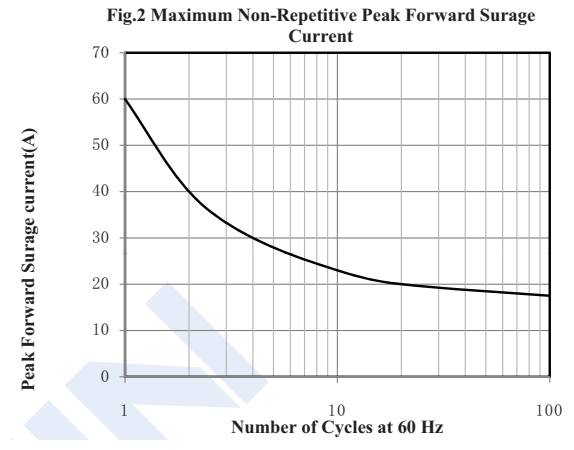
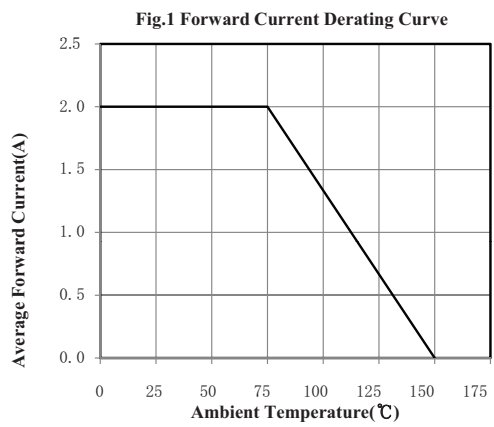

## Small Surface Mount Fast Recovery Rectifiers

### RS207FL

■ Package Outline Dimensions

Plastic surface mounted package; 2 leads

SOD-123FL

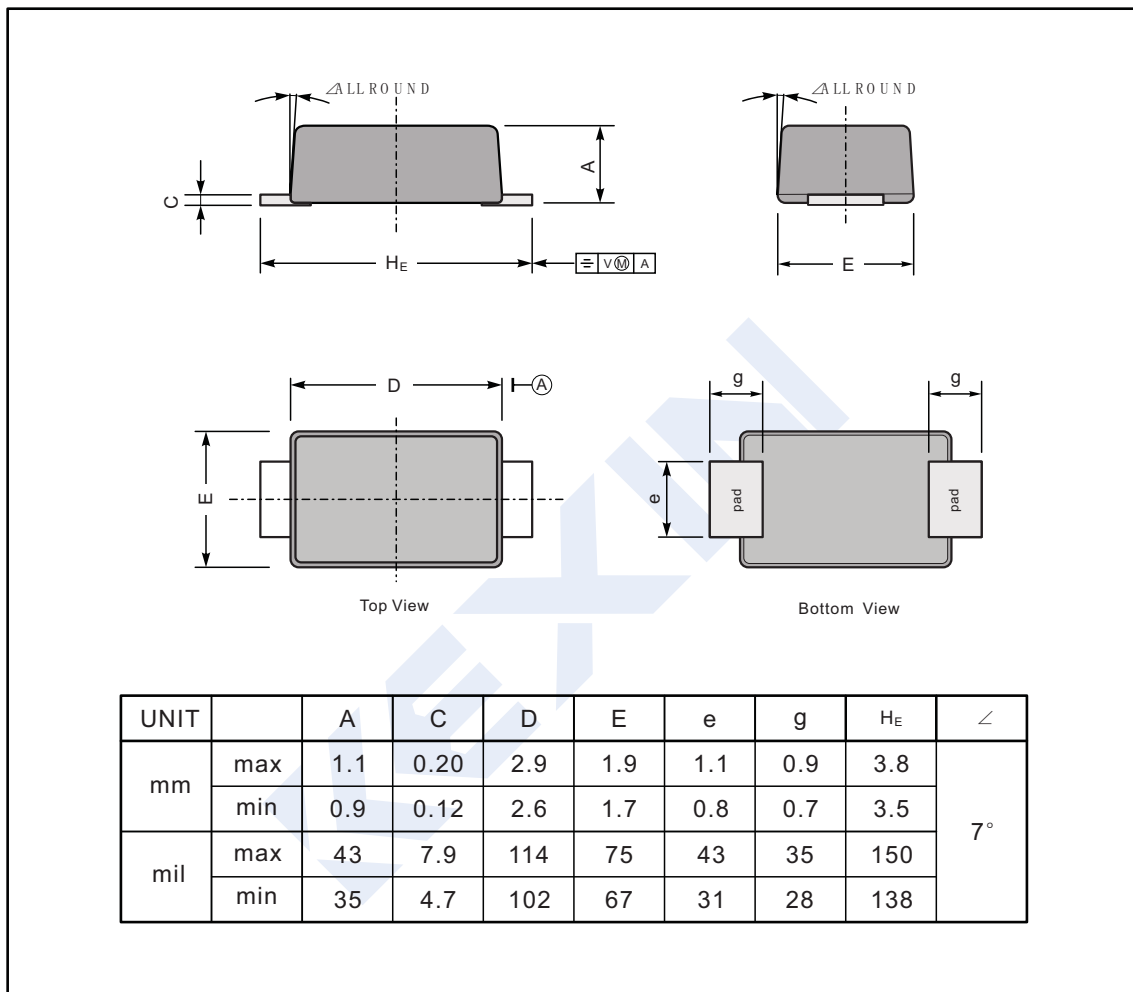

■ The recommended mounting pad size

