

N-Channel MOSFET

SIR422DP (KIR422DP)

■ Features

- $V_{DS} (V) = 40V$
- $I_D = 40 A (V_{GS} = 10V)$
- $R_{DS(ON)} < 7.5 m\Omega (V_{GS} = 10V)$
- $R_{DS(ON)} < 9 m\Omega (V_{GS} = 4.5V)$

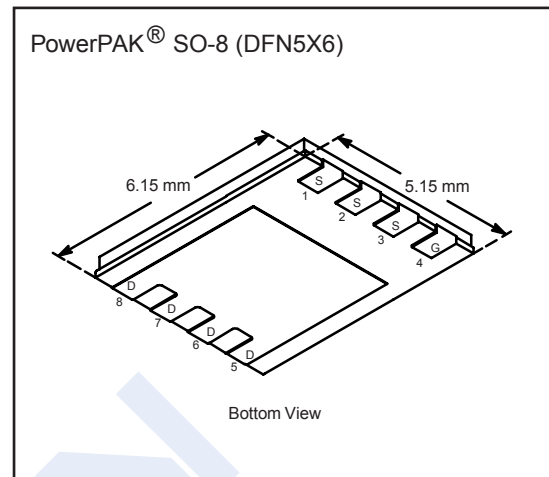
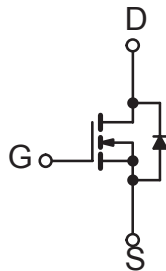

■ Absolute Maximum Ratings $T_a = 25^\circ C$

Parameter	Symbol	Rating	Unit	
Drain-Source Voltage	V_{DS}	40	V	
Gate-Source Voltage	V_{GS}	± 20		
Continuous Drain Current	I_D	$T_c=25^\circ C$	40	A
		$T_c=70^\circ C$	40	
		$T_a=25^\circ C$	20.5	
		$T_a=70^\circ C$	16.4	
Pulsed Drain Current	I_{DM}	70		
Avalanche Current	I_{AS}	30		
Avalanche Energy	E_{AS}	45	mJ	
Power Dissipation	P_D	$T_c=25^\circ C$	34.7	W
		$T_c=70^\circ C$	22.2	
		$T_a=25^\circ C$	5	
		$T_a=70^\circ C$	3.2	
Thermal Resistance.Junction- to-Ambient	R_{thJA}	25	$^\circ C/W$	
Thermal Resistance.Junction- to-Case	R_{thJC}	3.6		
Junction Temperature	T_J	150	$^\circ C$	
Storage Temperature Range	T_{stg}	-55 to 150		

N-Channel MOSFET

SIR422DP (KIR422DP)

■ Electrical Characteristics Ta = 25°C

Parameter	Symbol	Test Conditions	Min	Typ	Max	Unit	
Drain-Source Breakdown Voltage	V _{DSS}	I _D =250 μA, V _{GS} =0V	40			V	
Zero Gate Voltage Drain Current	I _{DSS}	V _{DS} =40V, V _{GS} =0V			1	μA	
		V _{DS} =40V, V _{GS} =0V, T _J =55°C			5		
Gate-Body Leakage Current	I _{GSS}	V _{DS} =0V, V _{GS} =±20V			±100	nA	
Gate Threshold Voltage	V _{GS(th)}	V _{DS} =V _{GS} , I _D =250 μA	1.2		2.5	V	
Static Drain-Source On-Resistance	R _{DS(on)}	V _{GS} =10V, I _D =20A (Note.1)			7.5	mΩ	
		V _{GS} =4.5V, I _D =15A (Note.1)			9		
On State Drain Current	I _{D(on)}	V _{GS} =10V, V _{DS} =5V (Note.1)	50			A	
Forward Transconductance	g _{FS}	V _{DS} =15V, I _D =20A (Note.1)		70		S	
Input Capacitance	C _{iss}	V _{GS} =0V, V _{DS} =20V, f=1MHz		1785		pF	
Output Capacitance	C _{oss}			264			
Reverse Transfer Capacitance	C _{rss}			120			
Gate Resistance	R _g	V _{GS} =0V, V _{DS} =0V, f=1MHz	0.2		1.6	Ω	
Total Gate Charge	Q _g	V _{GS} =10V, V _{DS} =20V, I _D =20A			48	nC	
		V _{GS} =4.5V, V _{DS} =20V, I _D =20A			25		
Gate Source Charge	Q _{gs}	V _{GS} =4.5V, V _{DS} =20V, I _D =20A		4.5			
Gate Drain Charge	Q _{gd}	V _{GS} =4.5V, V _{DS} =20V, I _D =20A		5.6			
Turn-On DelayTime	t _{d(on)}	V _{DD} = 20 V, R _L = 2 Ω I _D = 10 A, V _{GEN} = 4.5 V, R _g = 1 Ω			35	ns	
Turn-On Rise Time	t _r				145		
Turn-Off DelayTime	t _{d(off)}				55		
Turn-Off Fall Time	t _f				22		
Turn-On DelayTime	t _{d(on)}	V _{DD} = 20 V, R _L = 2 Ω I _D = 10 A, V _{GEN} = 10 V, R _g = 1 Ω			18	ns	
Turn-On Rise Time	t _r				20		
Turn-Off DelayTime	t _{d(off)}				40		
Turn-Off Fall Time	t _f				16		
Body Diode Reverse Recovery Time	t _{rr}	I _F = 10 A, di/dt = 100 A/μs, T _J = 25 °C			40	nC	
Body Diode Reverse Recovery Charge	Q _{rr}				25		
Reverse Recovery Fall Time	t _a			13			ns
Reverse Recovery Rise Time	t _b			9			
Maximum Body-Diode Continuous Current	I _S	T _C = 25 °C			40	A	
Pulse Diode Forward Current	I _{SM}				70		
Diode Forward Voltage	V _{SD}	I _S =4A, V _{GS} =0V			1.2	V	

Note.1: Pulse test; pulse width ≤ 300 μs, duty cycle ≤ 2 %.

N-Channel MOSFET SIR422DP (KIR422DP)

Typical Characteristics

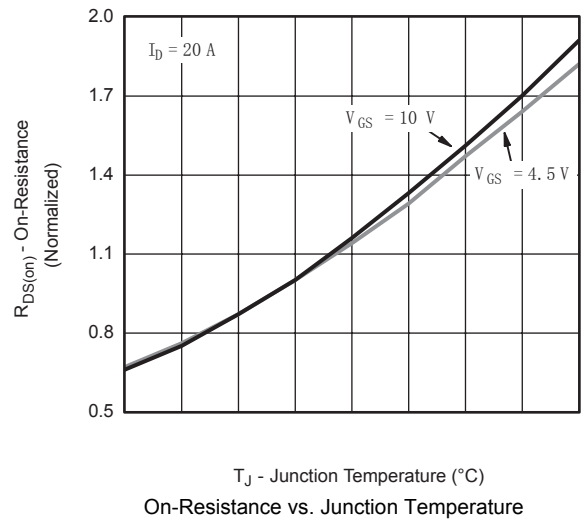
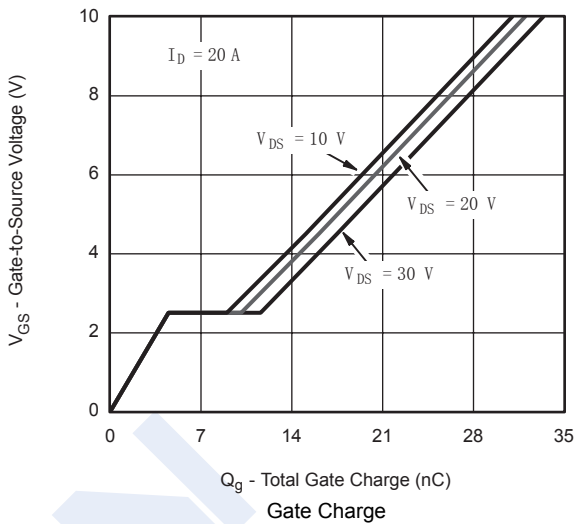
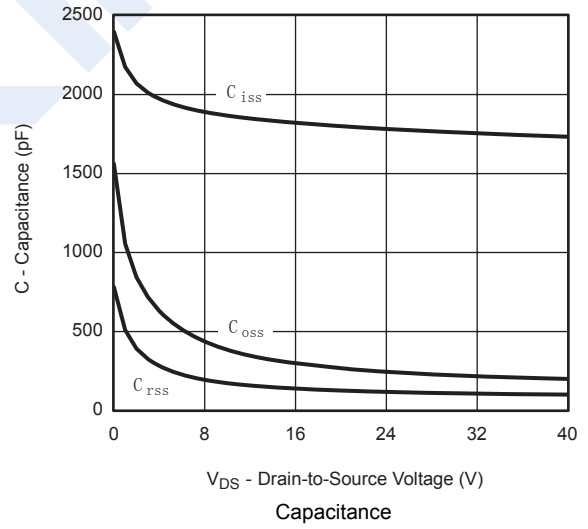
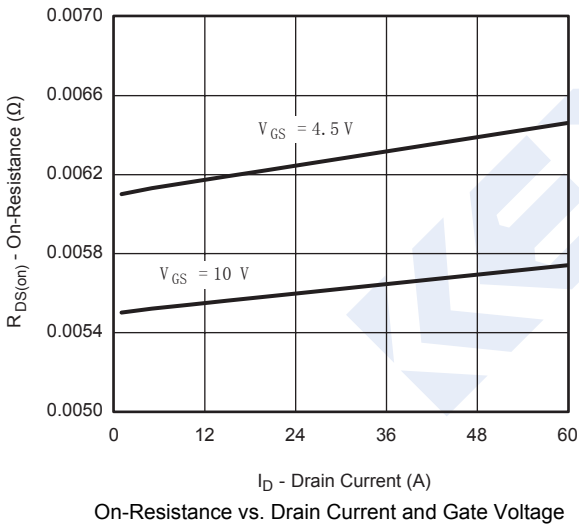
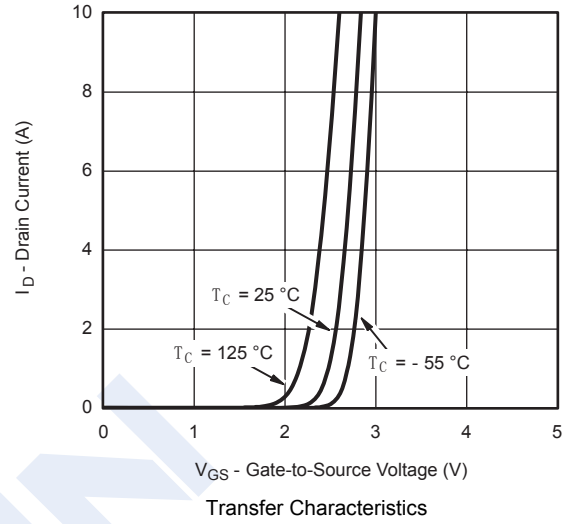
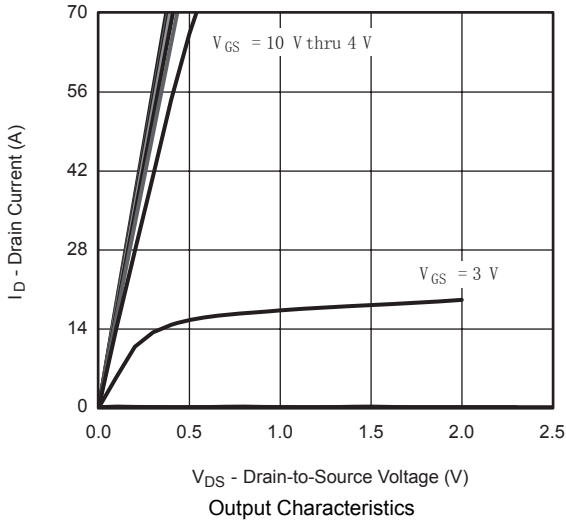

N-Channel MOSFET SIR422DP (KIR422DP)

Typical Characteristics

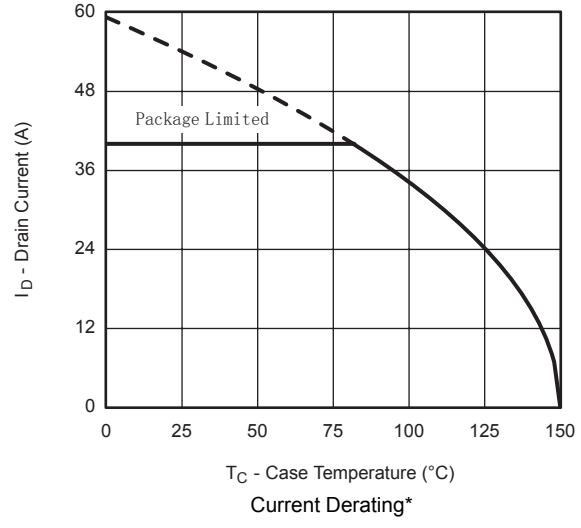
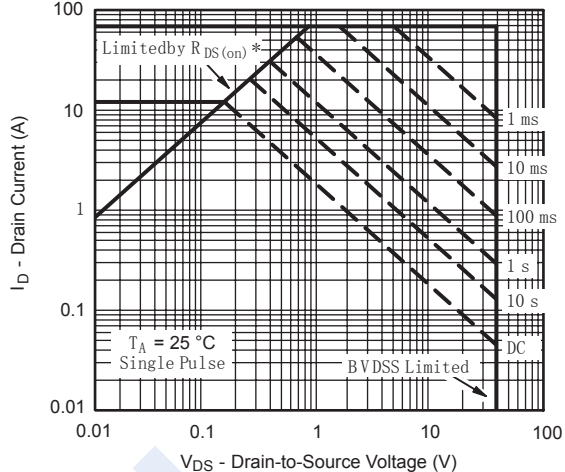
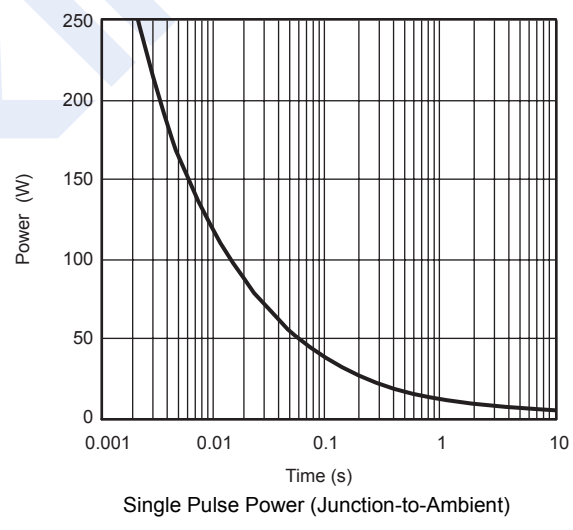
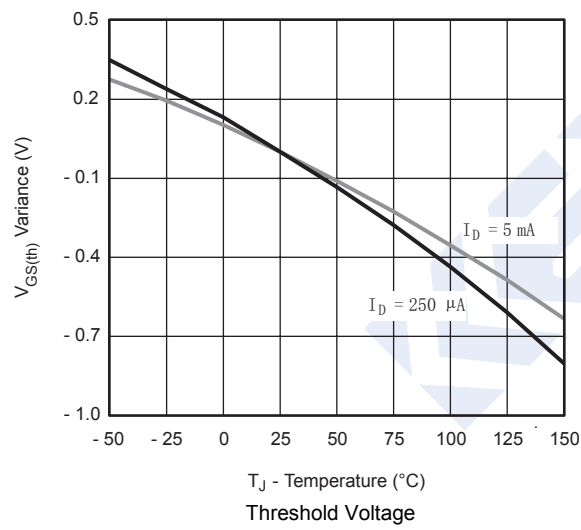
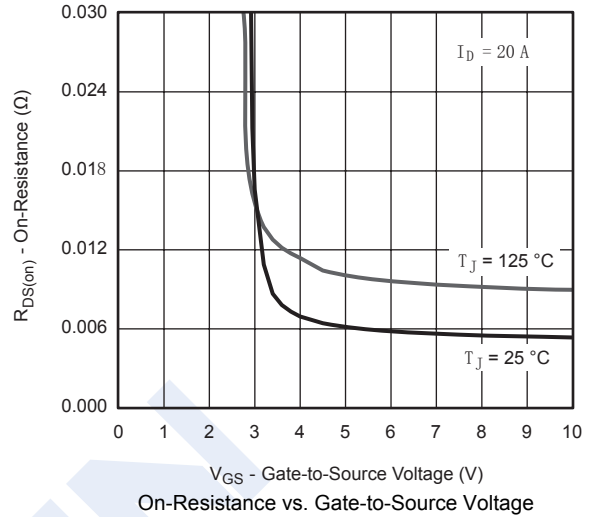
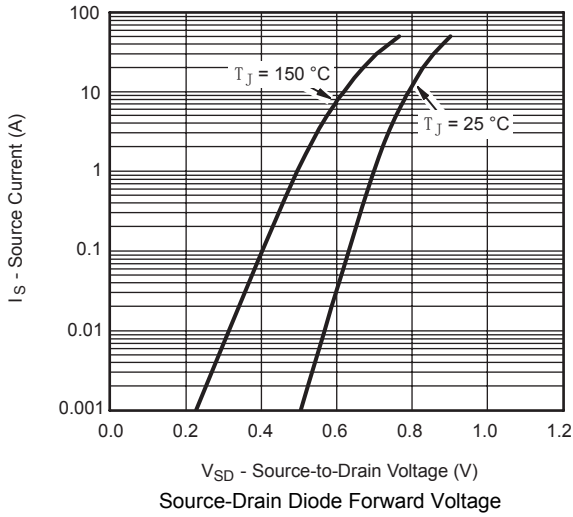

* $V_{GS} >$ minimum V_{GS} at which $R_{DS(on)}$ is specified

N-Channel MOSFET SIR422DP (KIR422DP)

■ Typical Characteristics

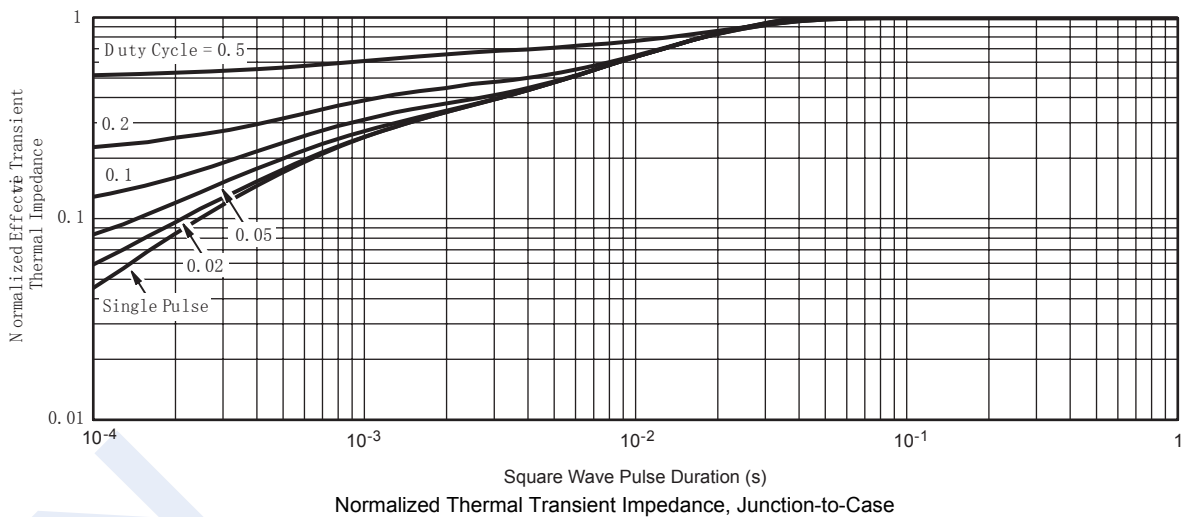
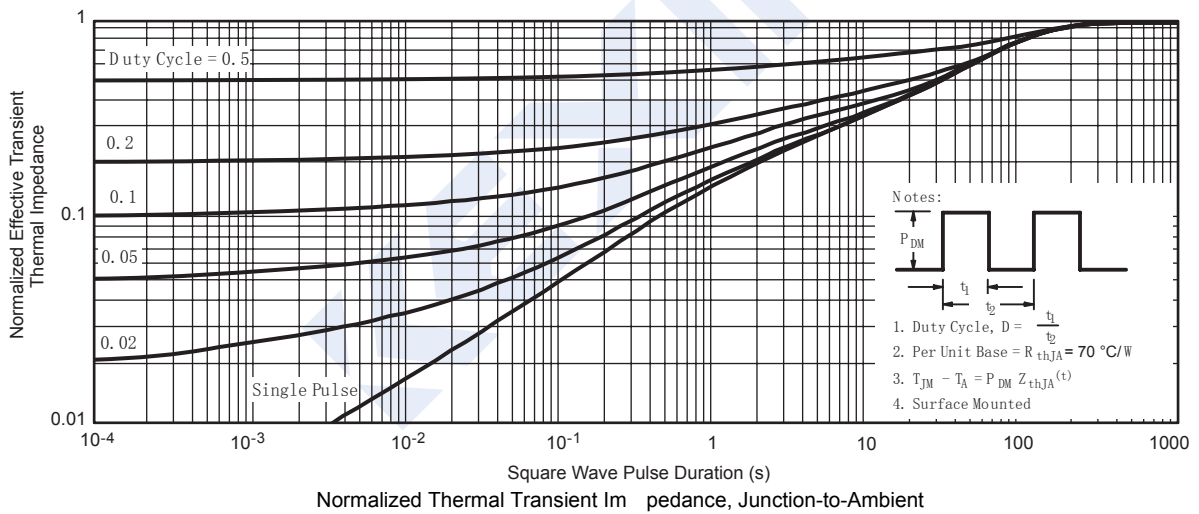
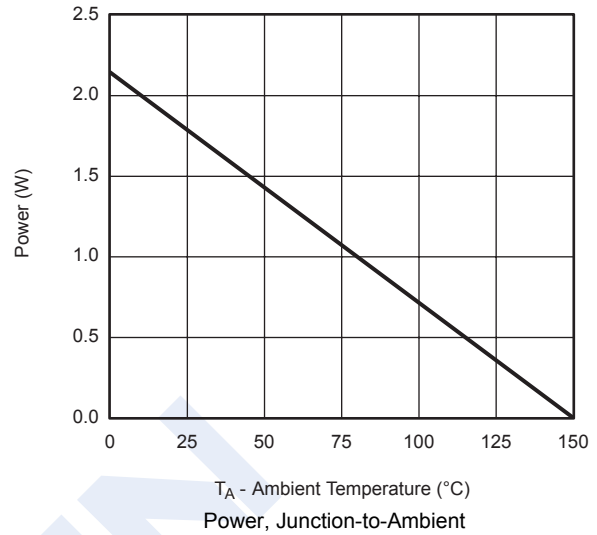
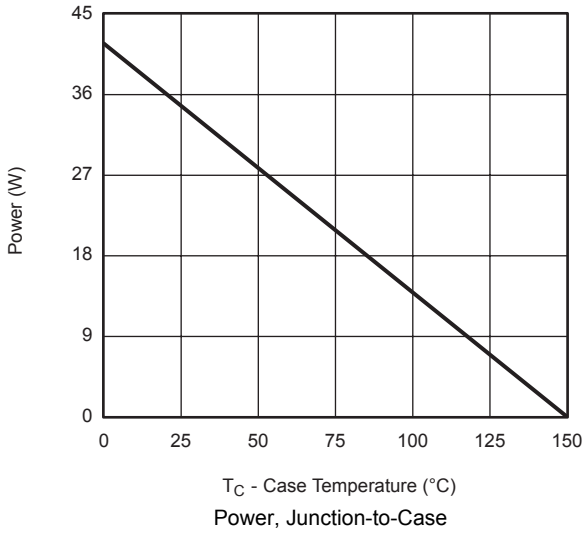

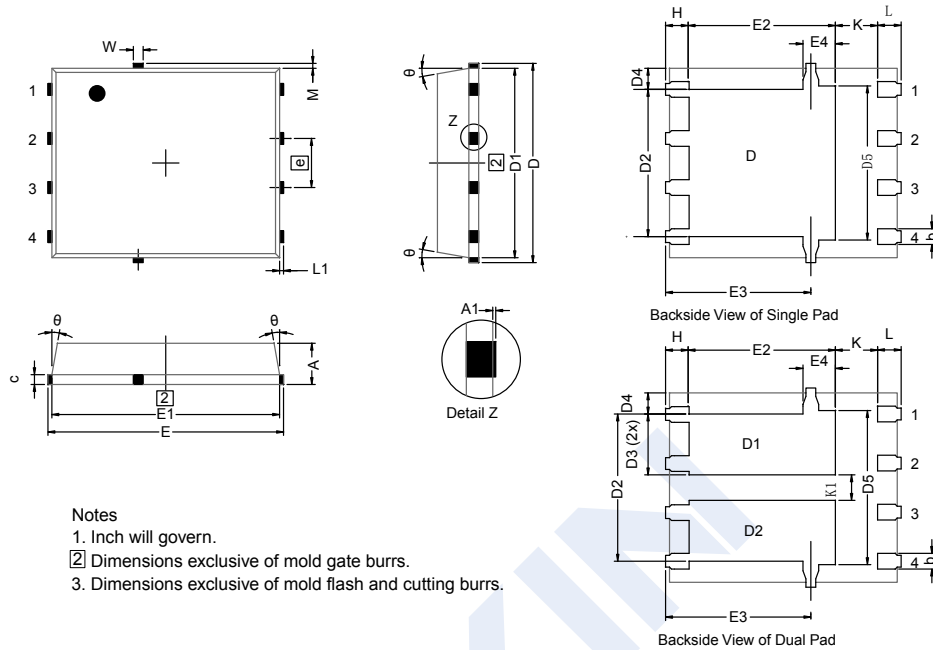
PowerPAK[®] SO-8(DFN5X6), (Single/Dual)

DIM.	MILLIMETERS			INCHES		
	MIN.	NOM.	MAX.	MIN.	NOM.	MAX.
A	0.97	1.04	1.12	0.038	0.041	0.044
A1		-	0.05	0	-	0.002
b	0.33	0.41	0.51	0.013	0.016	0.020
c	0.23	0.28	0.33	0.009	0.011	0.013
D	5.05	5.15	5.26	0.199	0.203	0.207
D1	4.80	4.90	5.00	0.189	0.193	0.197
D2	3.56	3.76	3.91	0.140	0.148	0.154
D3	1.32	1.50	1.68	0.052	0.059	0.066
D4	0.57 typ.			0.0225 typ.		
D5	3.98 typ.			0.157 typ.		
E	6.05	6.15	6.25	0.238	0.242	0.246
E1	5.79	5.89	5.99	0.228	0.232	0.236
E2 (for AL product)	3.30	3.48	3.66	0.130	0.137	0.144
E2 (for other product)	3.48	3.66	3.84	0.137	0.144	0.151
E3	3.68	3.78	3.91	0.145	0.149	0.154
E4 (for AL product)	0.58 typ.			0.023 typ.		
E4 (for other product)	0.75 typ.			0.030 typ.		
e	1.27 BSC			0.050 BSC		
K (for AL product)	1.45 typ.			0.057 typ.		
K (for other product)	1.27 typ.			0.050 typ.		
K1	0.56	-	-	0.022	-	-
H	0.51	0.61	0.71	0.020	0.024	0.028
L	0.51	0.61	0.71	0.020	0.024	0.028
L1	0.06	0.13	0.20	0.002	0.005	0.008
theta	0°	-	12°	0°	-	12°
W	0.15	0.25	0.36	0.006	0.010	0.014
M	0.125 typ.			0.005 typ.		