

## Schottky Diodes

## SS22 ~ SS220

## ■ Features

- Reverse Voltage - 20 to 200 V
- Forward Current - 2.0 A
- Metal silicon junction, majority carrier conduction
- For surface mounted applications
- Low power loss, high efficiency
- High forward surge current capability
- For use in low voltage, high frequency inverters, free wheeling, and polarity protection applications

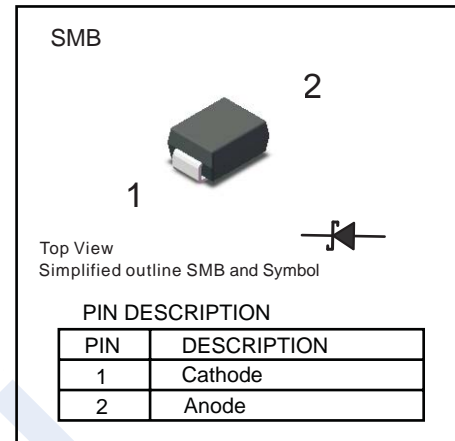

## ■ Absolute Maximum Ratings and Electrical characteristics

Ratings at 25°C ambient temperature unless otherwise specified.

Single phase half-wave 60 Hz, resistive or inductive load, for capacitive load current derate by 20 %.

Parameter	Symbols	SS 22	SS 24	SS 26	SS 28	SS 210	SS 212	SS 215	SS 220	Unit	
Maximum Repetitive Peak Reverse Voltage	$V_{RRM}$	20	40	60	80	100	120	150	200	V	
Maximum RMS voltage	$V_{RMS}$	14	28	42	56	70	84	105	140		
Maximum DC Blocking Voltage	$V_{DC}$	20	40	60	80	100	120	150	200		
Maximum Instantaneous Forward Voltage at 2A	$V_F$	0.55		0.70		0.85		0.95		A	
Maximum Averaged Forward Rectified Current	$I_{F(AV)}$	2.0									
Peak Forward Surge Current, 8.3 ms Single Half Sine Wave Superimposed on Rated Load	$I_{FSM}$	50									
Maximum DC Reverse Current $T_a=25^\circ\text{C}$ at rated DC blocking voltage $T_a=100^\circ\text{C}$	$I_R$	0.5			0.3			3			mA
Typical Junction Capacitance *1	$C_j$	220			80						pF
Typical Thermal Resistance *2	$R_{\theta JA}$	75									°C/W
Operating Junction Temperature Range	$T_j$	-55 ~ +125									°C
Storage Temperature Range	$T_{stg}$	-55 ~ +150									

\* 1 Measured at 1MHz and applied reverse voltage of 4V D.C.

\* 2 P.C.B. mounted with 2.0" x2.0" (5x5 cm) copper pad areas.

## ■ Marking

NO.	SS22	SS24	SS26	SS28	SS210	SS212	SS215	SS220
Marking	SS22	SS24	SS26	SS28	SS210	SS212	SS215	SS220

# Schottky Diodes

## SS22 ~ SS220

### ■ Typical Characteristics

Fig.1 Forward Current Derating Curve

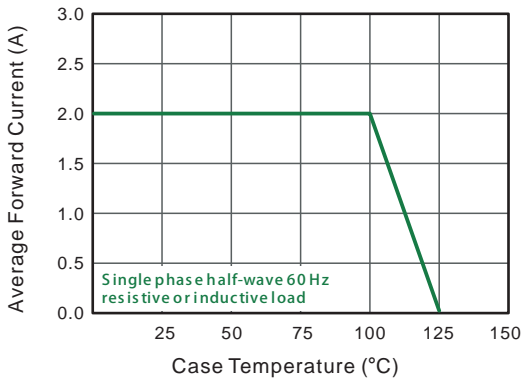

Fig.2 Typical Reverse Characteristics

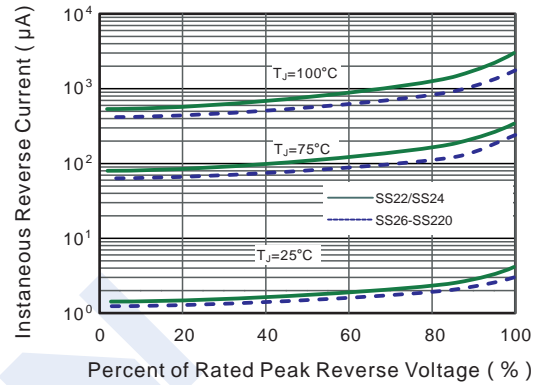

Fig.3 Typical Forward Characteristic

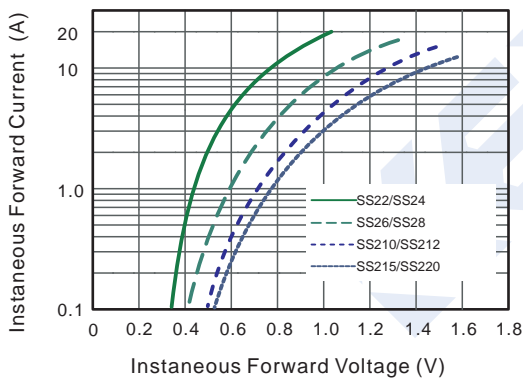

Fig.4 Typical Junction Capacitance

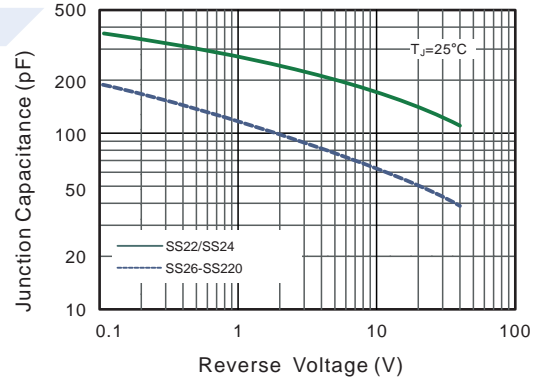

Fig.5 Maximum Non-Repetitive Peak Forward Surge Current

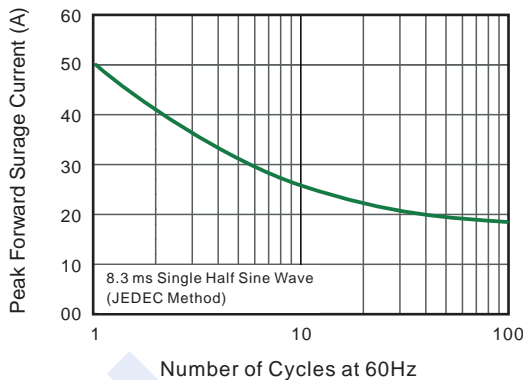
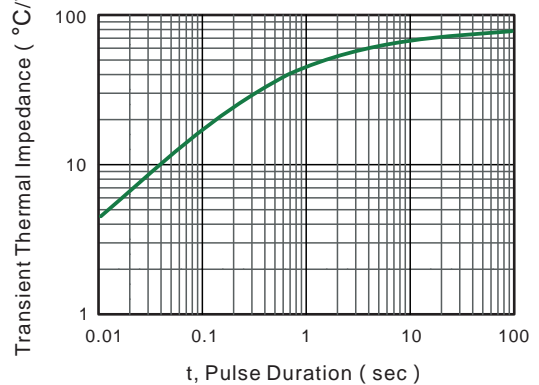

Fig.6- Typical Transient Thermal Impedance



## Schottky Diodes SS22 ~ SS220

■ Package Outline Dimensions

Plastic surface mounted package; 2 leads

SMB

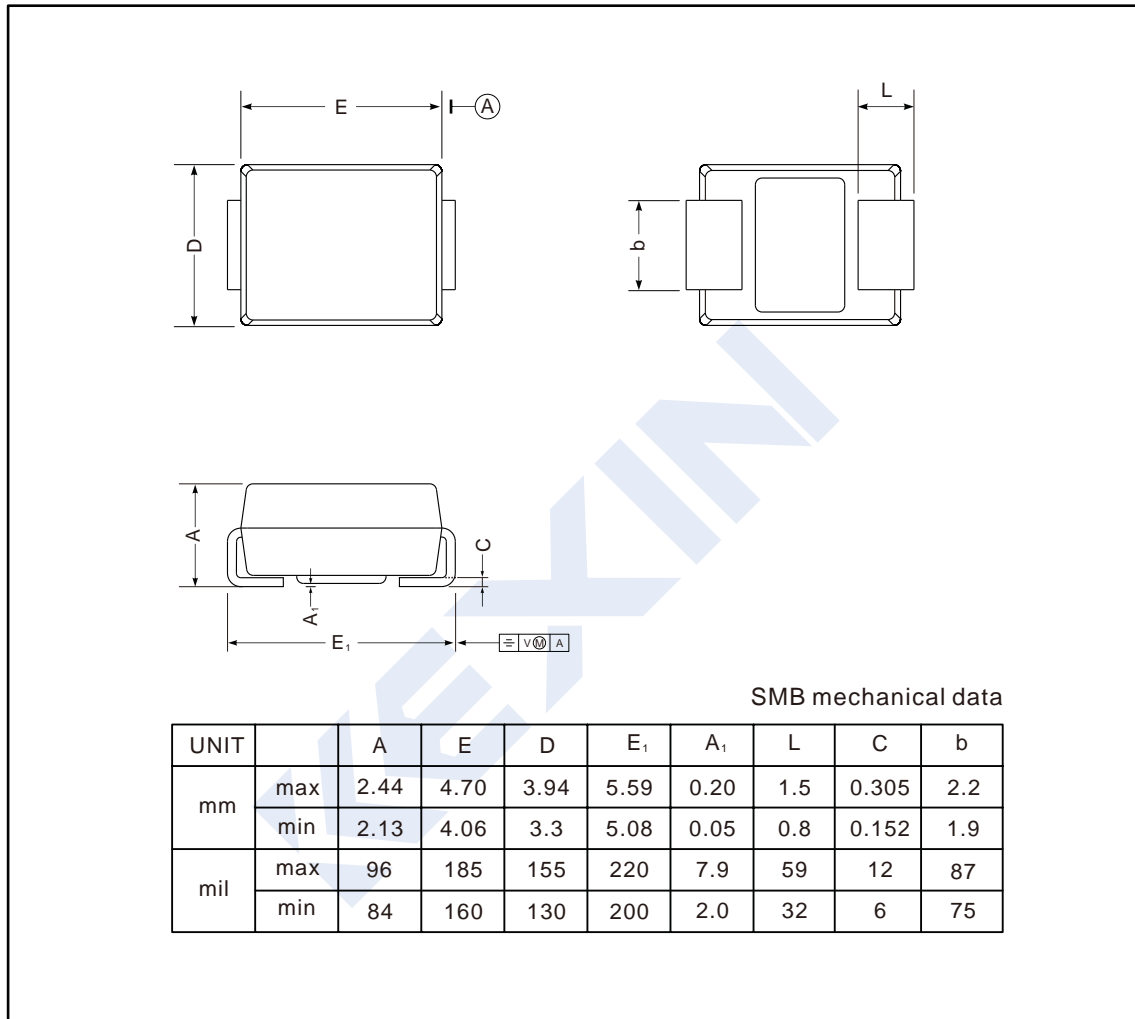

■ The Recommended Mounting Pad Size

